

# Make friends with your PC

Johann-Christian Hanke

© Copyright 2000 Author and KnowWare

## Acrobat Reader: How to ...

**F5/F6** open/closes bookmarks - **F4** open/closes thumbnails

**In menu View you can set, how the file is displayed**

**CTRL+0** = Fit in Window, **CTRL+1** = Actual size, **CTRL+2** = Fit width

You can set **SINGLE PAGE**, **CONTINUOUS VIEW** or **CONTINUOUS FACING**

.. try them out and you will see the differences.

### Navigation

**ARROW LEFT/RIGHT**: forward/backwards one page

**ALT+ARROW LEFT/RIGHT**: same as in a browser: forward/back

**CTRL++** zooms in **AND CTRL +-**  zooms out

Welcome .....	4	The final touches .....	39
Don't panic .....	4	DTP on a PC.....	40
About the author.....	4	Calculating in tables .....	40
Once upon a time - a little computer story.....	6	Numbers in cells.....	41
Good ideas.....	6	Sales tax and averages.....	41
Mechanical solutions.....	6	Mouse drawings.....	44
The electronic computer.....	7	Drawing with vectors.....	44
IBM & Co. ....	7	Everyone a van Gogh - painting programs .....	44
The journey to the moon.....	8	The data-base as information container ....	45
'User friendly' computers.....	8	You have won. ....	45
Computers get personal .....	9	Filtering data .....	45
DOS computers .....	9	Music on your PC .....	45
The Apple PC.....	10	It is the card which makes the noise.....	46
Summary.....	12	Composing without notes.....	46
Round the PC.....	13	Soundblaster.....	47
All computers are grey in the dark.....	13	Checkmate - but who? .....	47
The base of it all - the cabinet .....	13	Strategy and adventure .....	48
Monitor, keyboard & co. ....	14	Shoot'em ups.....	48
Diskettes (floppy disks) and CD-ROM .....	14	Dexterity and reactions .....	48
Of mice and men .....	15	Jump'n'Run.....	48
A peek beneath the bonnet .....	16	Simulation games.....	48
But who makes all that noise? .....	17	How much hardware do you need? .....	49
Motherboard.....	17	To steal or not to steal... ..	49
Good cards for all purposes .....	17	Multimedia and other fashions .....	50
The chip which works it all out .....	18	Moving images and music .....	50
Sending documents to storage.....	19	Guaranteed fun .....	50
RAM - you can never have enough .....	19	Multimedia PCs.....	51
Bits and bytes .....	21	Everybody's talking about it - the Internet.....	52
Take the bus to BIOS .....	21	A word wide spiders web .....	52
Software - not so hard! .....	23	E-Mail - express post! .....	52
Computers are stupid .....	23	Surfing along the three big W's.....	52
The operating system - full throttle .....	23	Home, sweet home - my own homepage ..	54
DOS - what on earth is that?.....	24	... me too, I want a PC! .....	55
Ready, steady, command line! .....	24	Which computer is my type? .....	55
Windows with colored symbols.....	25	Lots of lovely programs! .....	59
OS/2, a better operating system .....	27	What you get for your money - A licence to work .....	59
Unix for the Net.....	28	OEM or 'how to get cheap software'.....	59
Mac OS .....	29	Nearly free - pirate software .....	59
Novell Netware and Windows NT/2000 .....	29	Shareware - test before you buy .....	59
Driver - a kind of miniprogram .....	29	Freeware and Public Domain .....	59
File types and organization .....	30	Good and cheap .....	59
Document files .....	30	Brand names? .....	59
Program files.....	31	Be careful - all is not what it seems! .....	60
Trees which grow down into the ground .....	31	My PC is ill .....	61
Windows 95/98 - A window to the world....	33	What is a Virus? .....	61
Something borrowed... ..	34	PC workshops - expensive and not so good.....	61
Start with Start.....	34	A little about ergonomics .....	62
The great Windows comparison.....	34	Are you sitting comfortably?.....	62
Lighting Windows course.....	35	What resolution? .....	62
Starting a program .....	35	'Nerd speak' - a little PC encyclopaedia ....	63
The behaviour of the common window .....	36		
Save .....	37		
Closing a window .....	37		
From desktop to Recycle bin.....	37		
Out and explore with Explorer.....	38		
The PC as a typewriter .....	38		
A little keyboard abc.....	39		
Delete, paste, move .....	39		

## Welcome

to the land of the personal computer! To-day it is difficult to imagine a life without computers. More and more people spend their time 'in front of the screen'. The grey boxes have spread out of the office and into the home. Everywhere people are playing, writing, calculating, drawing, creating, organising, hearing music and watching videos, composing, programming and surfing the Internet. The possibilities are endless. Every day the PC becomes a more and more exciting hobby, but at the same time it is also becoming an essential work tool. If you can understand the PC, your chances of employment are considerably increased. Now even schoolchildren are taught to feel at ease working in this new medium.

Maybe you also want to play, write, calculate, draw, compose and realise your ideas, but you are not sure of your talents yet. Never mind.... everything can be learnt! Let us take a trip 'around the PC' and familiarise ourselves with this electronic helper!

### Don't panic

even if you have never used a PC before and are not sure if you can understand anything! We will be talking English here, not nerd-talk. You do not even need to own a PC to understand this booklet, which is written especially for the beginner. I have also been a (stupid) learner once, not so long ago, in fact.

If you already own a PC and have some experience, you will certainly learn something here. You will find a mass of information and good ideas within the next 60 pages. We will look around the PC - in detail but in an easy to understand fashion, and to make sure that we have missed nothing we will also open it up, though only in our imagination. You will see what you can do with a PC and the best way to use it. We will be looking at the following subjects

- a short history of the PC
- The Apple Macintosh
- A peek into a PC

- software/hardware
- programs
- multimedia
- The Internet
- What sort of hardware and software to buy

If you are not so interested in a particular subject, then just skip it. There is a table of contents on the back page. If you are looking for something particular, then look in the index. At the end of the booklet is a little glossary, under the title 'Nerd-talk - A little PC dictionary' where you can find all the words indicated in the text with a little arrow, like → **binary system**. This also contains some terms that are not included within the body of the book.

We will also take a quick look at some programs. This will give you an idea of what you can do with your PC. You will see what you can achieve using a word processor or a spreadsheet. Maybe you will be so enthusiastic about a particular program that you will want to learn it better. In that case you will probably find that KnowWare has published a booklet which can help you.



### About the author

There is not so much to write about. Even at the age of 30 I am a bit of a clean sheet. I studied German and English at university, and then had to fit into the job market. I took the risky decision to make my hobby my job and now work as a freelance writer, writing books, articles and essays on subjects such as computers. I also write short stories.

I have other strings to my bow. I am a qualified adult education teacher and give regular courses on different computer programs (Windows, Word and Excel) and also in German. I prefer teaching at night-school, I find the pupils more open, motivated and curious. I have a talent for going to the core of a subject very quickly and seeing how I can explain it so it can be understood immediately. This makes every course a party, and not just for the pupils!

And by the way, in my book there are no 'stupid' pupils, just teachers who cannot teach!

So I wish you many 'Wow!' experiences and happy hours with your PC.

Johann-Christian Hanke

### **Important**

Even though we are at the very beginning you should remember that computers have their limits. They can never (luckily) replace the creative human being. A computer is never better than its user and the developers who wrote the programs. Computing is only possible because of the people who invented it.

Even a complete beginner can learn in a relatively short time how to master and use a personal computer. No special talents are needed, just some get-up-and-go, interest, curiosity and imagination.

### **Your opinion is important**

Nobody is perfect. So maybe you have some ideas about what I could have done better. Maybe you felt that some important information was missing. Maybe this booklet has helped you be good friends with your computer. Hopefully you will feel your understanding deepen as you read, and will be able to join in if the conversation turns to computers! I feel it is important that you get a broad view.

I am interested in your experiences, so you are welcome to write to me if you wish. Please send a letter with your comments. If you can access the Internet it is even better if you will send me an e-mail. On page 52 you can see how you can do this. I look forward to hearing from you! If you write an ordinary letter, write in English, German or Danish and send your letter to KnowWare in Denmark, who will forward it to me.

### **Many thanks**

to these good friends, without whose help this booklet could never have become what it is:

- Rosemarie, who let me work on her Mac
- Matthias for info about OS/2
- Matthias for info about Unix
- Stefan, who showed me his collection of multimedia CDs
- Wolfgang and Brigitte for proof-reading
- Elke and Karl for technical advice
- Karin for many good tips
- Thea for patience (wow.)
- Michael from KnowWare
- Ingo Steinhaus, who, without knowing it, inspired me

I take full responsibility for any mistakes and inaccuracies.

## Once upon a time - a little computer story

The word computer comes from the Latin *computare*, which means to *calculate* or *add together*. So a computer is something which can calculate. There were actually computers in the 18th century, except at that time the word did not mean a machine, but a person who understood mathematics. A computer was someone who carried out complicated calculations for other people. The concept of a computer in a technical sense first appeared during the 19th century.

### Good ideas

Let us jump back to England in the 19th century. The buzzwords at that time were: industrial revolution, machines, coal and the textile industry. The island empire showed the way for the rest of the world. At that time England was the place for economic growth. It was here that the ideas of the future were developing. In the first half of the 19th century the Frenchman Jacquard had developed a weaving machine which worked by being programmed with punchcards. The famous Jacquard loom soon took over in England. This inspired the Englishman **Charles Babbage** to use the same method of programming to control a *calculating machine* which worked completely mechanically. A machine which could calculate - why not? Maybe it could even be steam driven - at that time steam was a very important energy source. Unfortunately the standard of workmanship available at the time made the idea technically impossible. Babbage's brilliant idea had popped up a century too early.



**fig. 1:**  
**England**

### Mechanical solutions

Simple mechanical calculating machines first really made their mark at the turn of this century, though even these could not really be called computers. They could manage addition and subtraction, so they were a great help with bookkeeping, but

more complicated calculations were more than these simple hand-driven machines could manage.

Now we take a trip to Germany. This excursion is rather interesting, at the very least it is a geographical exception in the history of computing. Here the building engineer **Konrad Zuse** gave a lot of thought as to how the existing level of technology could be utilised to construct an automatic calculating machine. In his opinion the → **decimal system** was not really suitable for mechanical calculators. It is very practical for us humans to use numbers like 1, 2, 3.10, 11 etc., but for a machine it is far too complicated. So instead Zuse used the → **binary system**. In this system every decimal number is shown as a combination of 1s and 0s. The decimal numbers 0 and 1 are already binary numbers, but as soon as we reach 2 the binary system shows it as 10 (one-zero) and 3 becomes 11 (one-one). A value of one can be symbolised electronically by the current being switched on, whilst it is switched off to represent a zero value.

Zuse achieved this effect by using telephone relays. A relay is a remote controlled electronic contact which can switch current on and off. Incidentally, this on or off (1 or 0) state can also be called a → **bit**. So a bit is either 0 or 1!

By 1941 the idea was ready. Konrad Zuse built *the world's first fully functional programmable calculating machine*, the **Z3**. The machine could manage a simple multiplication in about 3 seconds. It had about 2,000 relays and read the program from punched tape. During wartime this punched tape was manufactured from left-over film stock to save resources. Using the Z3 as a starting point a calculator was planned which would use electronic valves. Valves such as these were very common at the time, they were used, for instance, in the amplifiers in radio sets. They are another form of switch, but react at much higher speeds than mechanical relays.

But this completely electronic calculating machine never saw the light of day, luckily one might say. It was, like the Z3, a top-secret weapon for the Nazi regime, and it was designed to be used for military purposes. This was also one reason that the world never heard of this important invention, and to this day the Americans insist that it was they who invented the computer.

### The electronic computer

It is an unfortunate fact of life that important inventions so often come from military needs. At about the same



fig. 2: well.

time that the German invention was being developed, the USA was also developing an electronic calculating machine, and here as well it was a military project – it could hardly be otherwise. Scientists in Pennsylvania worked intensely for the American defence ministry to develop a 'super-brain' which could calculate gunnery tables. The idea was that the machine would be in use for the World War II, but it was not finished before 1946. Its parents were two scientists named Mauchley and Eckert, and the child, a real monster which filled a large hall, was named **ENIAC**. It weighed 30 tons, contained 18,000 valves and a half a million soldered connections. It used so much electricity that it needed its own power generator. The enormous apparatus could do about as much as a modern pocket calculator and was very complicated to re-program. A battalion of helpers was needed to operate the 6,000 contacts and several hundred connectors. Defective valves needed to be replaced and loose connections repaired continuously to keep the machine operating, but at least it was a start.

The world's first production computer, **UNIVAC**, first saw the light of day in 1951 and also came from Eckert and Mauchley. UNIVAC became especially well known during the American presidential election of 1952. It was a very close race, and nobody could say with certainty if it would be Stevenson or Eisenhower who would take the prize. UNIVAC was used to

produce an educated guess as to whom the winner would be. It became something of a media spectacle and radio programs across the USA ran reports. The superbrain was fed with 5% of the votes cast and foresaw a clear victory for Eisenhower, which nobody was willing to believe, everything pointed to a victory for Stevenson. So the reporters killed the live transmission from the computer and mocked the 'stupid machine'. Of course, the very thing which nobody had thought possible happened, Eisenhower won with a clear majority! The country was shaken, artificial intelligence had shown that it could produce the correct result with its calculations. This presidential election and UNIVAC's part in it was the start of the computer's victory march. UNIVAC became famous and even ended up playing the main role in several Hollywood films.

### IBM & Co.

IBM – the historic company which has produced machines for office use since 1924, has played a huge role in the history of computers. In the beginning the firm produced electronic typewriters and punch-card calculators, but by the 1950s they had won a large part of the market for desk calculators. The first electric data management system was produced in 1952, and from 1953 onward the firm built the legendary **IBM 650**. This calculating machine became the most widely used data processing system in the world at the time. The IBM 650 was called the 'Volkswagen computer', not least because of IBM's excellent customer service. By the end of the 50s IBM controlled three-quarters of the market and the company was to remain the unchallenged market leader in data processing for many decades.

It was also in the fifties that the transistor seriously became a force to be reckoned with. This electronic keystone was actually invented in 1947 and was a new development within electronic switch technology, based on semiconductors. It reacted hundreds of times faster than a valve, took up

only a tenth of the space and needed less electricity.

At the same time the fifties saw a wave of controversy about the computer's negative sides. People foresaw a future of mass unemployment and economic crisis. In fact it was the opposite which occurred! The economy boomed like never before. New industries were created next to the rapidly growing valve and transistor industry. Computer experts were needed and demand hugely exceeded supply.

### The journey to the moon

In those times, as today, speed was the main criteria for the evolution of calculating machines. The integrated circuit, invented in 1958, contained a large number of transistors in a very small area – today this can be many thousands. Short connections meant even higher speeds. But despite this the new 'microchip' started as a flop – it was too expensive and complicated to produce. Once again a special need had to arise before development could really get going.

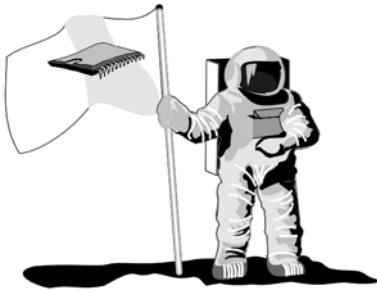

**fig. 3: Man in the moon**

When the Russians sent the first man up into space in 1961 it set a ... well, a rocket under the USA. This was in the middle of the cold war and space projects carried a lot of prestige. The 'land of opportunity' could not accept this 'disgrace'. President Kennedy announced to the American people that the USA would send a man to the moon before the end of the decade. No sooner said than done! But this prestigious project would need an especially small and light computer – after all, every gram was important in such a small space capsule. So it was decided to continue to develop the integrated circuit, and the

whole project came to its triumphant success in 1969 – Apollo 11 touched down on the moon. Guidance was carried out using a completely new type of computer, at that time the world's smallest and most modern!

The basic principle of the computer, the way it calculates using 0 and 1, is the same today. Even the IC (integrated circuit) did not alter that. But in the following years it was another area that changed out of all recognition: the way that the computer was manipulated by its users. The fastest computers, those produced using integrated circuits, were especially difficult to use and program. The computer was still seen as a clever machine, but one which was difficult to understand and could only be used by highly qualified personnel.

### 'User friendly' computers

It ought to be so easy to use a computer that even a child can manage it. This was the thought that occurred in some bright heads at the Xerox company, when they developed what they dubbed the 'graphic user-interface' at their research laboratory in California. Their idea, to start with a child's senses of touch and sight was not just immediately illuminating, it was also just as simple as it was clever. To use the sense of touch the scientists developed a small box which could be pushed backwards and forwards on a surface like a table. The movements of this object would be transmitted down a cable and made visible on the screen. And this was the birth of the computer 'mouse' – because the little box with its long wire tale resembled this small grey rodent. By using this → **mouse** objects can be moved and manipulated. The objects which Xerox developed for this system consisted of a complete office system with documents, folders and filing cabinets. The entire system was formed graphically. The mouse was used to point at an object – a picture on the screen, for instance – and this picture, which could represent something like document folder, could be moved by moving the mouse backwards

and forwards on the table. This caused the object to move in a similar fashion, and the entire system was named an 'intuitive system'. Touch and sight were formed into a single system, but it was to take nearly 10 years before the idea really broke through.

### Computers get personal

Until the beginning of the 70s it was the mainframe computer which dominated the landscape. A mainframe no longer filled an entire hall, but it still took up a lot of room. The



fig. 4: mainframe

electronic valve had given way to the transistor and the integrated circuit, and punched cards and tape were a thing of the past when it came to data storage, overtaken by magnetic tape and its technology. Communication with the super-brains now took place via a **terminal**. This was a type of operating panel, consisting of a keyboard and maybe a printer, which was later supplemented by a monitor. Several thousand terminals could be attached to one mainframe.

The IBM company still dominated the production of mainframes. The chiefs there were not particularly troubled by the fact that since the beginning of the seventies small and practical computers had been made. What on earth could these weak little boxes be used for? The computer kit called the **Altair 8800**, for example, was clearly just for people who loved to fiddle around with soldering irons. It had no screen or keyboard, but the price was just right, the Altair 8800 cost a mere 397 dollars! At the time it was something of a sensation. So it did not matter that the case only contained some switches, a few small bulbs and a simple calculating chip. Computer pioneers wrote programs and swapped information at computer exhibitions. Some bright spark quickly realised that the beast could make music. And then developments arrived on the market,

a TV could be attached, or a cassette recorder. So then everyone could have their own personal computer, completely independent of any mainframe.

The first important PCs were produced at the end of the seventies by the Apple company, Commodore and Tandy, but IBM continued to hold the mainframe market in an iron grip. The new PC trend could only move forward slowly.

### DOS computers

When it comes to new trends, the largest of firms are often the slowest. The computer giant IBM seemed to be entirely unaware of the development of the personal computer, but at the beginning of the 1980s the whole game changed. After an extremely short development time IBM launched the first economically competitive personal computer on the market in **1981**.

Within a very short time this personal workstation became a huge success, and the machine did not even contain state of the art technology! The fact that the **IBM PC** became an industry standard was due to other reasons.

For instance the giant firm threw itself into a huge advertising campaign. The landscape was plastered with television commercials and newspaper advertisements. Everything – it was claimed – could now be done easier and with fewer problems. The PC was the personal helper for the daily routine. Incidentally, the term 'personal computer' first won acceptance thanks to IBM's campaign!

Whilst other manufacturers like Apple took great pains to keep the internal design of their machines secret and would only allow their subcontractors to produce for them, IBM went in the opposite direction. The IBM PC was an open system. Accessories for this machine could be developed and produced by any manufacturer.

Even the chip or → **processor** started off by being produced by the **Intel** company, but it was not long before competing firms began producing calculating chips which were cheaper and better. At the same

time, Intel was able to deliver its products to other firms and it was not long before many companies started copying IBM computers, producing what became known as IBM compatible computers, or 'clones'.

Compatible means that these machines function like one of the original machines from IBM, but these clones were much cheaper, and helped ensure the success of this type of computer.

These days a 'real' IBM produced PC is more the exception than the rule!

Compatibility was the real keyword, also when it came to programs. Old applications which had been run on IBM's mainframes could be shifted relatively simply to the new PCs, but whereas previously every computer producer had stuck to their own methods, the new IBM machines and their clones were compatible with each other. So all data could be exchanged from machine to machine without problem. This process was encouraged in no small part by a software company which has now become the world's largest – Microsoft. IBM had decided to buy a program from this very young and enthusiastic firm, a program which was to be the → **operating system**.

This operating system, called → **DOS**, and MS-DOS (from Microsoft) was installed on (nearly) all IBM PCs. Most clone manufacturers also bought DOS and installed it on their machines. So now you know why an IBM compatible computer can also be called a DOS computer. And, incidentally, it did not take long for DOS to be copied. On page 23 you can find out more about the subject of → **Software** and operating systems.

So it was in 1981 that the success story of the personal computer really began. And the standards were written by IBM and Microsoft.



**fig. 5: original IBM PC**

## The Apple PC

I am sure that insiders will forgive me when I call a computer from the Apple company a PC. Apple enthusiasts and IBM users sometimes seem to be fighting a nearly religious war, but in fact an Apple computer is a personal computer. It is of no importance that the company designed its computers without any regard for the standards which were set by Microsoft and IBM.

So it was not an open system, but a proprietary one. It was not possible to simply open the case and drop in a new accessory. At that time this could only be done with IBM computers.

Programs for an Apple computer could *only* run on an Apple. And the company expected a higher price for its products – no surprise as its suppliers did not really have any competition.

Finally in **1984** the Apple PC became famous. At this time they launched the **Macintosh**, a strange little beast. Instead of the designers using several rectangular boxes, they decided on a compact little cabinet. This had a built-in black and white screen and could be carried around on a journey without too much problem, but the big attraction was the user interface, the way the Mac was operated.

So the first graphic user interface appeared in 1984 on the Mac. Apple had gone back to Xerox's idea and by exploiting it had come up with an entirely new philosophy of computer use. While IBM users laboriously learnt commands and wore their fingers down to the bone on the keyboard, the Mac let the user move small symbols, like folders and files, around with the mouse. The use of the mouse was in itself something of a revolution! The little computer beast had to wait several years before it could win a similar victory on the IBM computer.



**fig. 6: an early Mac**

At last the PC had become something for everyone. Unpack it, switch on, and start, that was the way it could be done with the friendly little Mac. Many small businesses and home users chose a Mac as their first computer. It was often a choice: *either a car, or a Mac!*

Back then, when my friends enthused about 'their Apple' their eyes lit up. Everything was just SO easy! If you wanted to delete a file, for instance, all you had to do was drag it to the trash can, and I was sick in my head as I thought of my confusion with the dismal DOS computers I used at university.

And as well as all this the developers had included a nice drawing program, a little musical program and even a flight simulator with these first Macs! Overall this machine was especially useful for graphics, music and design. As early as 1985 a program appeared which could be used professionally for layout for newspapers and books – **PageMaker**. It is no surprise that Apple's PC was soon the first choice for graphic artists, designers and, later, for → **Multimedia**-designers.

Nowadays an Apple PC goes under the name of a Performa or a Power-Mac and looks like a 'real PC', with the usual separate screen. My first meeting with a Mac was not until last year – during a temporary office job, but all my high expectations were dashed – obviously I must have encountered a whole series of 'Monday morning' machines.

The Apples worked slowly and crashed repeatedly – a crash is when nothing works and the machine freezes up. Not only this, there was always some machine or another which had to be sent to the workshop. Since then I have regularly come into contact with Macs, but my bad experiences have repeated themselves every time. I have always found that these machines worked more slowly and were less stable than DOS computers.

Today little remains of the giant which was Apple. Bad production strategies have pushed the firm deep into the red, and now they are fighting just to survive. It is a shame, but in the fast moving computer

market even large firms can disappear nearly overnight. There is one glimmer of hope: Microsoft itself is now giving Apple financial support! In most of the world about 5 - 7% of PCs in use are Macs, in the USA this figure is still about 40%. A Mac is more than just a computer, it is a lifestyle!

## Summary

The table below shows the most important events in computer history. It makes no claim to be complete – in keeping with this entire history of the personal computer.

Date	Event	Keywords
18th century	'Computers' used for difficult calculations	important components: <b>biological</b>
early 20th century	<b>Simple calculating machines</b> carry out tasks like bookkeeping	<b>mechanical</b>
1941	<b>Konrad Zuse</b> develops the world's first operating programmable calculating machine, the <b>Z3</b>	mechanical with <b>relays</b> and punched tape
1946	<b>ENIAC</b> constructed in the USA	electronic, using <b>valves</b>
1951	<b>UNIVAC</b> follows ENIAC, <b>computer mania</b> begins	uses <b>valves</b>
since the 1950s	<b>IBM</b> dominate the computer market's production of mainframes	valves and <b>transistors</b> , punched tape, punched cards and magnetic tape
1969	The world's smallest and most modern computer takes <b>Apollo 11</b> safely to the moon	integrated circuits ( <b>ICs</b> )
1970s	<b>Xerox</b> in California develop the <b>graphic interface</b> with mouse control	
1974	The <b>Altair 8800</b> computer kit goes on sale for \$397	<b>ICs</b> , no screen or keyboard
1970s	the first personal computers for business use are produced	<b>ICs</b> minimal sales figures
1981	Trend-setter <b>IBM</b> introduces the term 'personal computer' and experiences a huge success with its PC	<b>ICs</b> , <b>open system</b> (easy to add to), diskettes
1981	<b>Microsoft</b> delivers the <b>DOS</b> operating system for the IBM PC	continual development since this time
1984	The <b>Apple Macintosh</b> with its graphic user interface becomes a huge success	<b>ICs</b> , compact cabinet, <b>high user friendliness</b> , diskettes
1990s	<b>Windows</b> operating system from Microsoft becomes a huge success (more on page 25)	for <b>IBM compatible</b> machines, very user friendly
1999/2000	<b>You work with a computer for the first time</b>	<b>with great success</b> ☺

**fig. 7: Summary of the history of the development of the computer**

## Round the PC

When, with fear and trepidation, I sat down in front of a computer for the first time a few years ago the question which pained me the most was 'which should be switched on first, the screen or the grey box?'

My conscience told me to switch the box on first, followed by the screen. Today I know that it makes no difference, maybe on

your computer they both switch on together as they are connected to each other. If that is the case then that is one less thing you need to worry about!

In those days I looked with wonder at the people who first clicked here, then there, then pressed some keys, and then arrived painlessly at a result. I was happy enough just to be able to find the power switch – not always an easy task on some models. But before switching the computer on, let us take a look at some of its components.

### All computers are grey in the dark

And most of them are also grey in the light as well! Mouse grey and boring shades of it – mouse, monitor, keyboard, case, printer etc. Only rarely does a colored PC pop up. Will it ever be otherwise? Bill Gates – the founder of the software company Microsoft, a visionary and one of the world's richest people, foresees a 'Wallet PC', the size of a credit card. We will always have them with us, helping us plan our daily routine, booking and paying for cinema or theatre tickets, presenting our credentials and so on. When this time comes we will almost certainly put great weight on having the latest colors. A grey 'credit card'? That doesn't really say very much about us!

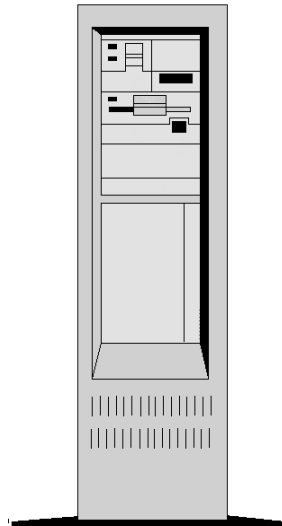

fig. 8: Big Tower

### The base of it all – the cabinet

But back to the present. At the moment a computer consists of several components. The most important of which is not the monitor – no, it is the **cabinet**. This is where the music plays, here is where the important bits are to be found. This cabinet can take various forms. It can sit on your desk, and hence be called a **desktop cabinet**.

The next picture shows a desktop cabinet, which has the advantage of being the right size to place the monitor on, and so avoid having to practice 'office gymnastics' when you want to put a diskette in the machine. Another very popular type of cabinet is the **minitower**. This is a small upright box which can be pushed in under your desk. This is the type of cabinet I have myself. A minitower is more spacious and can contain more accessories.

There is also the **tower cabinet**. As the name suggests, this is a 'tower', a high upright box. This is very practical if you want a lot of accessories – several hard disks, a CD-ROM drive, a sound card and so on. (more about accessories on the next pages). But this type of cabinet contains mainly air and empty space. If you do not have much room and are not especially interested in accessories, then the best choice is a **minitower**. The portable → **laptops** or → **notebooks** are even smaller and contain all components in the smallest possible space.

## Monitor, keyboard & co.

The **monitor** is simply a screen, a device to show output, actually nothing more than a television set without speaker or tuner, but due to its much higher quality a computer screen is more expensive than a TV set, after all, you will be sitting very close to it, hopefully without suffering eye-strain. The → **resolution** of a computer monitor is much better than a television, and the same is true of its → **refresh rate**, this is the speed at which the picture is built up. A normal TV has a refresh rate of 50 pictures per second (50 Hz), and even that has to be achieved with a bit of cheating. The flickering box is aptly named – it flickers! A (better) PC monitor has a refresh rate of at least 71 pictures per second. This fools the eye and no flicker is visible. Most PC monitors also give off very little radiation, very strict controls have made high demands on producers. There are apparently people (like me) who sit 12 hours or more every day in front of these beasts. To start with a 15 inch monitor will be fine. Architects and multimedia developers (whatever that may mean) use a minimum 17 inch screen, and often choose 21 inch screens. A computer monitor of this size can cost up to \$1.500, but beware, monitor producers can be just as optimistic in the measurements as television set producers.

The **keyboard** looks at first glance like the one we are used to from an ordinary typewriter, but there are many extra keys. You communicate with the computer using the keyboard (and mouse), so the keyboard is an input device. This practical piece of equipment is attached to the cabinet via a cable, and it should then be positioned in a good place on your desk. It will normally have small legs which can be used to adjust the angle. On page 39 you will find a short description of the keys and their functions.

The **Mouse** is described more thoroughly in its own chapter. It is also an input device. Our picture shows a rather old model.

The **Printer** is, like the monitor, the most important output device. After all, nor-

mally you will not just want to see how wonderful your work is on screen, but would prefer to hold it, in black and white – or multi-colored and white if you want – in your hand. The printer in the picture is not so up-to-date dot matrix type. The different types of printer are described further on page 57.

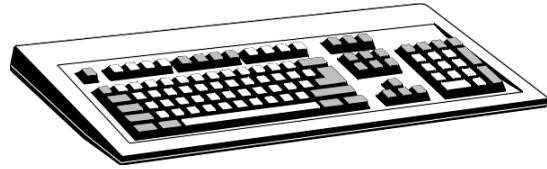

fig. 9: a modern PC keyboard

Incidentally, **speakers** or a **microphone** can be connected to the PC – but in this case a sound-card also needs to be built in.

## Diskettes (floppy disks) and CD-ROM

It was something of an advance when the mainframe machine's magnetic tapes were replaced by small, practical **diskettes**, also known as **floppy disks**. The first PCs used diskettes to save data on. Home computers like the C 64, a very popular model in the 1980s, started by using magnetic tape for data storage. A diskette is a flat plastic square with a circular magnetic disk inside. The first diskettes could store very little data, not more than 360

→ **Kilobytes**.

Later higher quality, dustproof types came on the market. Today a diskette can contain 1.44

→ **Megabyte**, which is approximately 500 normal typewritten

pages. But this booklet with all its illustrations could not fit on a diskette – pictures take up far more space. When a diskette is placed in the appropriate drive it is spun round and read by a read/write head. The principle is the same as a cassette tape, or a music CD or record. Diskettes can, like cassettes, also have their contents deleted. This can also happen by accident, if you move a magnet



fig. 10: HD-diskettes

over them! A 1.44 MB standard diskette measures 3 ½ inches across. The diskette in the illustration is a 1.44 model and represents today's standard. They are also called HD diskettes. HD standing for high density – the high density allowing high capacity.

Older diskette types are very seldom used. Incidentally, help is at hand to prevent accidental deletion: modern diskettes have a little slider, which can be used to open or close a hole. If both holes on the diskette are open it can only be read and so cannot be accidentally deleted. This is called a 'write protected' diskette. If only one hole is open, the diskette can be written to.



**fig. 11: CD-ROM**

A man comes into a bookshop and asks for a travel guide. The book-seller wants to show off his new elec-

tronic offer and suggests a **CD-ROM**.

"No," says the man, "I hate Italy, I would prefer a CD-Paris".

OK, I admit it, it was not a very good pun, but if the man had owned a multimedia PC with a CD-ROM drive he might well have accepted the offer. Something like a travel guide can really demonstrate this medium's strong points. Text, speech, video, animation and sound can all whet the armchair travellers' appetite for a journey to Greece, France or the Pyrenees. By the way, CD-ROM means 'Read Only Memory', because this storage medium can only be read and not written to. On the other hand with its 700 MB capacity it can hold a lot. A many volume encyclopaedia can easily be contained on one silver disk. It can even contain a film, as long as it is no longer than an hour.

An 'accident' with a magnet is also impossible with a CD, it does not store data magnetically but as small depressions in the surface. So here they are again, the ones and zeros of digital data management. So if you really want to use all your energy to delete a CD, the only way to do

it is scratch the entire surface with a needle.

A computer CD-ROM is an exact twin copy of its musical brother. If you have a → **sound card** in your PC you can also play audio CDs in it. Unfortunately the opposite is not true. Nearly all newer computers today come equipped with a CD-ROM player as standard.

The successor of the CD-ROM is called DVD (Digital Versatile Disk). This brand-new storage system has up to 25 times more capacity!

## Of mice and men

Maybe you know the famous and gripping John Steinbeck novel. Maybe you have also seen the excellent film version with John Malkovich. Steinbeck describes the hard and



**fig. 12: Mouse**

poverty stricken life of American farm labourers in the 1930s. Lennie, who is rather simple, longs for warmth and love. During the course of the film he catches mice which he keeps in his trouser pocket. But every time he wants to caress them it all goes wrong. The poor animals cannot survive long between his clumsy hands.

A computer mouse also needs gentle handling, just like its namesake in the wild. A mouse is nothing more than a small box with a freely mounted plastic ball which turns as you move the mouse around on your desk, or better still on a special mouse mat or pad. The movement of the ball is translated to electronic signals which are sent via a cable to the computer, and then to the screen. A mouse will have either two or three buttons, excepting Apple mice which only have one.

Do not be afraid of the mouse. If you want to move the arrow or cursor on the screen just move it smoothly in the direction you want to move. If you want to *click* then press once on the *left* mouse button. If you

want to *double-click*, that means pressing *twice* in quick succession on the *left mouse button*. You may have to practice this movement some. If you come to the edge of the mouse pad, lift up the mouse and place it in a more convenient place. While you do this the ball will not move and neither will the cursor on the screen. I usually hold the mouse loosely between my thumb and ring finger, this makes it very easy to move.

Your forefinger will be just over the left mouse button, ready for action. It is best if your hand rests on a slightly raised support., or you will end up with cramp. There should also be room enough on your desktop for both mouse pad and your hand!

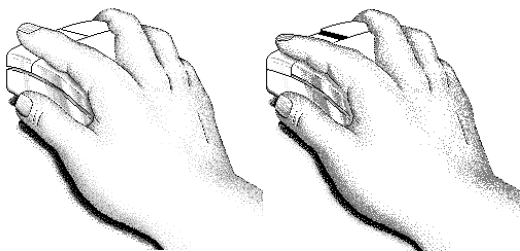

**fig. 13: clicking with the left hand mouse button**

It is a question of exercising to get used to the mouse. Some people find it easy to learn, others have problems. If you want to practice, → **Windows** comes with a useful card game, the well known 'solitaire'. This will let you try clicking and holding down the mouse button, moving an object with the mouse, and then releasing the mouse button again. You will find [Solitaire](#) among the games.

The mouse needs some regular care and attention.

If its ball gets dirty the cursor on the screen will no longer follow its movements exactly. If this happens then you should carefully remove the ball from its housing and rinse it – alcohol is the best to use. This is usually a very easy operation. You simply rotate a small ring underneath the mouse in the direction indicated by the arrows and it will be lying in your hand. Try it, it will give you a chance to get a little friendlier with your little computer rodent.



**fig. 14: a trackball**

The 'mouse substitute' or **trackball** is something I cannot come to terms with. A trackball is a mouse lying on its back. I think it is harder to control, and this amputated mouse gets dirty very quickly as the ball is virtually uncovered. Notebooks often use such a system, or have a 'help-mouse' integrated into the keyboard as it is usually difficult to find a place to use a real mouse when on the move. Despite this I would suggest using a real mouse.

### **A peek beneath the bonnet**

Let us now take a look into the depths of the **cabinet**, for the PC is an open system. It is built up in *modules* which can easily be taken apart and its components are replaceable, a very important point. Unlike a video recorder or a television you can, and may, open your computer and replace single components or modules as much as you want. This is very practical. This is the way you can upgrade your system. Practical or less practical accessories can be supplemented with others. For example you could add a sound card or more RAM – and you will find out later what that is. Upgrading means that you can keep replacing obsolete parts with the latest technology. There are hobbyists who consider this a sport and use all their free time doing just that. It might mean that your computer will work slightly faster than it did before. It can also mean that your computer simply stops working, but I have to admit that my computer's insides have got younger with time! IBM compatible PCs have always had this option, right from day one, while it has been nearly impossible to do the same with Apple machines.

## But who makes all that noise?

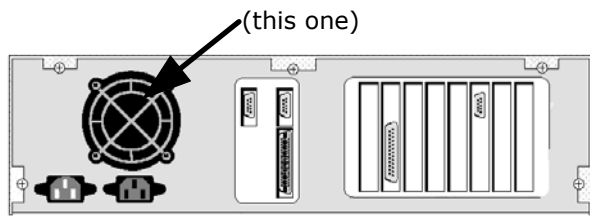

**fig. 15: a PC from behind**

This is all the fault of the **power supply** (guess what that does). It is equipped with a fan, which is hardly ever silent. Especially older machines let the world know of their existence via this constant racket, but there is nothing to do about it as otherwise the important components will simply die of overheating. The fan not only looks after the powersupply but sucks cool air through the entire machine – so now you know that there is so much air inside the beast. Modern fans are connected to a thermostat to keep the noise down to a bearable level.

## Motherboard

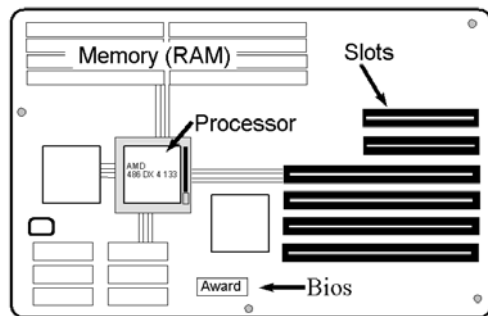

**fig. 16: Motherboard, schematic**

A motherboard is a more or less flat board to which are soldered or attached a number of chips and other components, connected to each other by strips of copper, a printed circuit. The motherboard is the heart of the PC. Let us now look at the other parts which are attached to it.

## Good cards for all purposes

A motherboard has several connections for expansion cards, such as a **sound card** which I mentioned before. Such a card contains electronic components which can produce sound. These mainly consist of the components for an amplifier and a connector for speakers or headphones. Of

course, such a multi-talented noisemaker will also allow you to attach a microphone.

Other **expansion cards** have other purposes. A video (or graphic) card will create picture signals which are then sent to the monitor. So a video card also has a monitor connection, accessible from the back of the computer. This card works with the monitor to give the best possible picture. A good graphic card does not come cheap.

While we are talking about connections, the printer and the mouse are usually connected to sockets on the back of the computer using an expansion card, this time called a **controller card**. This huge 'switching station' also ensures that the diskette drive, the hard drive and the CD-ROM can all talk to each other within the machine. Newer computers have managed to do without this card – the controller sits directly on the motherboard. In truth everything is on the one board!

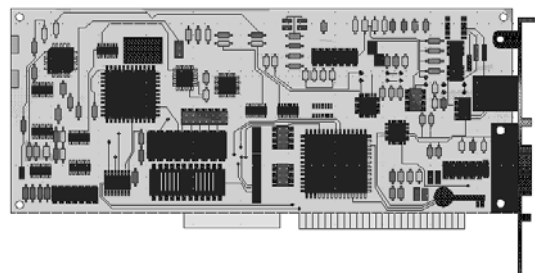

**fig. 17: typical PC expansion card**

If you want to watch television on your PC this is also possible, using a **TV card**.

There are also cards which will let you watch and edit VHS video, i.e. ordinary video tapes, on your computer. These are called **video capture cards**. If your computer is part of a network, connected to other computers, then it will contain a **network card**.

Type (Intel)	year	clock frequency	transistors	information
8088	1979	to 10 MHz	29.000	in the first IBM PCs from 1981
80286	1982	to 12 MHz	134.000	typical processor up to the late 1980s
80386	1986	to 32 MHz	275.000	minimum to run the old style Windows
80486	1989	from 40 MHz	1,2 Mill.	minimum to run Windows 95/98
Pentium (80586)	1993	from 66 MHz	3,1 Mill.	minimum to run Windows 2000
Pentium Pro/II/III	1995-99	from 200/233 MHz	from 5,5 Mill.	minimum for modern games

**fig. 18: Different processors and their properties**

### The chip which works it all out

Together with the motherboard the **processor** is the most vital part of a computer. This precious little thingamajig is a highly integrated chip sitting directly on the motherboard. The processor calculates, manages and coordinates everything happening in the PC. The processor and the motherboard are mainly responsible for the speed of the PC.

Newer processors sit in a socket and, with a little care and luck, can be replaced with newer models. These calculating chips are real work horses and can easily overheat. For this reason some of the newer models come complete with their own little cooling fans.

The processor is such an important part of the computer that they often give it its name. The following table summarises processor types and their names. The faster the → **clock frequency**, the faster the processor.

Even though some processor types have been produced for many years, more modern chips of the same family are always faster than their older brothers. It is not unusual that a newer (80)486 processor from 1996, can do better than an old Pentium from 1994.

This also has something to do with the every increasing clock frequencies available. There are users who modernise their PCs several times a year so they can al-

ways play the hottest PC games. But such game fans also need a good monthly income!

An entry level chip (suitable for beginners) of the Pentium type currently (fall '99) costs about \$US90. Such a chip is the AMD K6-III with a clock frequency of 400 MHz (it is not produced by Intel and so may not be called a 'Pentium'). An AMD Athlon chip (the fastest processor) with a clock frequency of 700 MHz costs about \$US800.

If you want an Intel Pentium III chip with a clock frequency of 600 MHz and → **MMX technology**, then at the time of writing you will have to pay about \$US700, a high price for a chip. If all you work with is straight word processing then you will have a hard time noticing any difference. You might find that a document will be printed out a couple of seconds quicker.

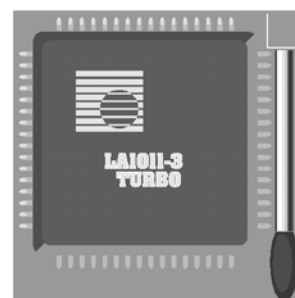

**fig. 19: A processor chip in its socket**

A games freak should be given a lot of sympathy. It is not enough just to replace the processor. There is more to come – a

faster graphic card, more RAM, a new motherboard ... STOP! Let us return to reality – the hard disk.

### Sending documents to storage

The **hard disk** in a computer is an integrated storage media with high capacity. The hard disk does not just have much more space than a diskette, it is also far faster. In contrast to a diskette it consists of *several* magnetic disks or plates set one above the other on a central spindle. All these disks are hermetically sealed within a small case with no contact whatever to the outside world. The entry of the tiniest dust particle would be a catastrophe for these fragile plates. When the computer is switched on, these disks spin round. Several read/write heads move over their surfaces and read or write data.



**fig. 20: Hard disk, interior**

You can visualise a hard disk as an old fashioned filing cabinet. As long as the computer is switched on the filing cabinet is open. As soon as something (which is to say a file) is stored it is saved on the hard disk (i.e. it is put in a drawer). When the PC gets something from the disk, or writes something to it you can usually hear a kind of clicking sound. When you switch your PC off, these 'documents' are stored in safety. A hard disk has a lifetime of about three to six years, but if the mechanics are over-used they can easily be worn out.

At the time of writing, modern hard disks have a capacity of 5,120 MB (5 GB) and up. Diskettes with their paltry 1.44 MB are just a tiny little note-pad in comparison. But on the other hand, they are easy to transport!

And incidentally, the earliest PCs did not have a hard disk, though they usually came equipped with two diskette drives.

### RAM – you can never have enough

On the motherboard you will find some insignificant little chips, which are not as unimportant as they look. These are the computer's working memory, and are called → **RAM (Random Access Memory** – i.e. memory which can be accessed at any point, not just at the beginning). This is a memory area which can be read from and written to extremely quickly. Storage here is exclusively electronic. All instructions to the computer and all the information it is working on is stored in this RAM, but only for as long as the computer is switched on.

And what does that mean in practice? You can visualise RAM as a work table which is available while the machine is running. This is where the most important data is stored. It is much faster to get it from this work table than to laboriously open the filing cabinet to find it. The larger the area of the work table, the better.

Such a working memory has always been part of a computer, but at the beginning of the 1980s a computer with 1 MB RAM, really something to be proud of. Today 32 MB is virtually a minimum. In the early days 1 MB cost a fortune, today 64 MB will cost about \$US30. You can always upgrade your RAM.

As stated, RAM is a very quick form of memory. But it has some serious disadvantages. If the power supply is cut off, or if the system freezes, then all the data it contains is lost. Imagine a gigantic arm which sweeps everything off the work table, but when its contents fall on the floor, they are lost forever.

The work table – better to call it working memory – is a very volatile memory, in contrast to diskettes and the hard disk which stores data permanently. So you should regularly save your data on your hard disk or on diskettes!

For this purpose all programs contain a command called **save**. If you write some text on your PC and forget to save it, then it is lost if there is a power cut. Only storing it on the hard disk, in your filing cabinet, will let you avoid such a painful loss.

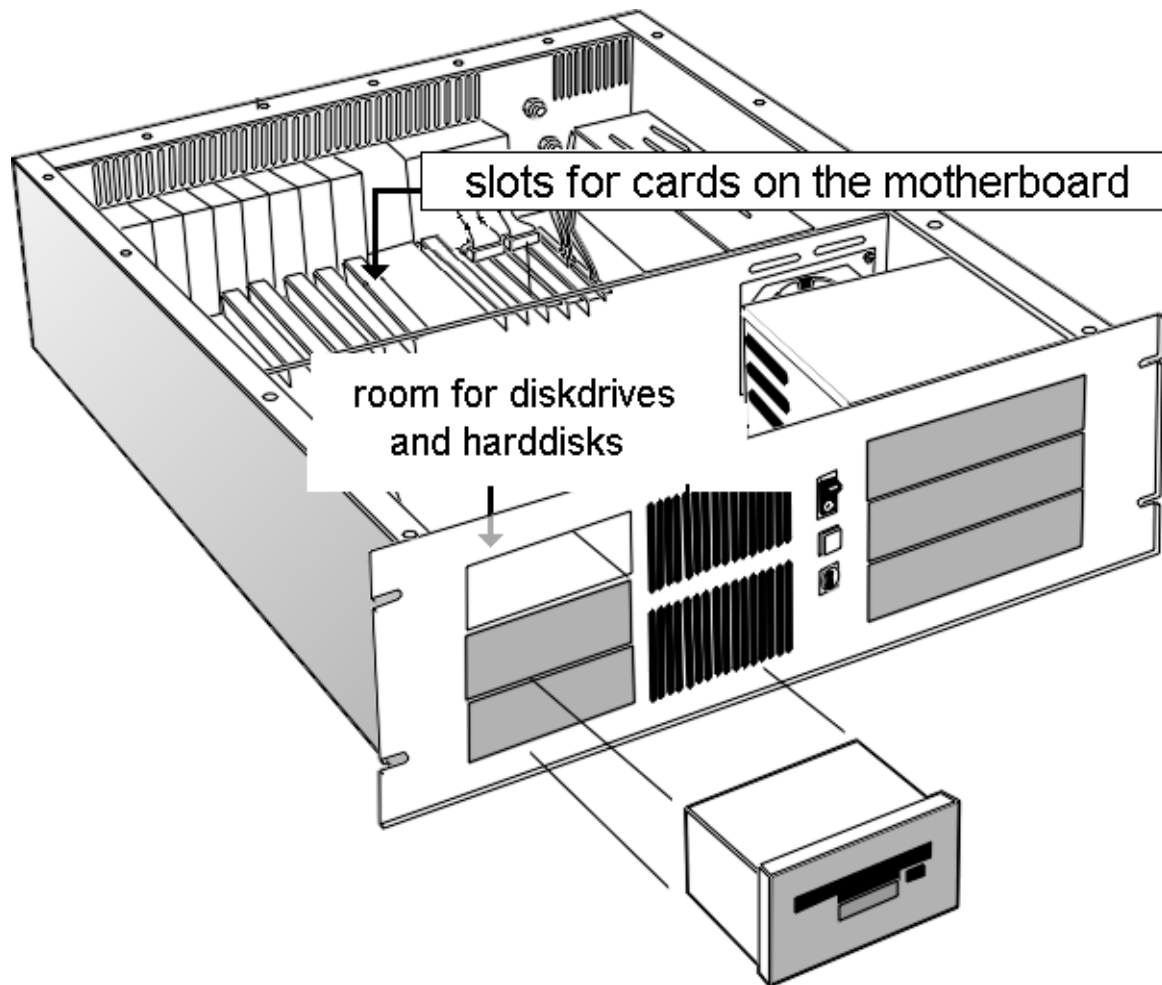

## Bits and bytes

Sorry, this is going to get a little technical. I have illustrated each data media's capacity with some real life examples: sheets of A4 paper or numbers of books. As you can remember, a diskette contains 1.44 Megabyte (MB), a CD-ROM holds (nearly) 700 MB, and a hard disk like mine holds 1.7 Gigabytes etc.

In theory this is enough for you to know, so you can skip over the next chapter if you want. But if you really want to know what is going on, please feel free to proceed!

On page 6 I mentioned a → **bit**. This is the smallest amount of information a computer can work with and save. It is an artificial word made up from the words **binary digit**. In good English (no comment) it is a number in the binary system, either a 1 or a 0, switched on or off, but a normal PC needs eight bits in order to show a character.

An A or a number 9 or a ☺ consists of a combination of eight 1 or 0s. 8 bits are a byte. A character is a byte is eight bits. This system allows for the display of 256 different states or characters. Let us take a closer look: 00000000, 00000001, 00000011, 00000111, .. -  $2^8$  comes to exactly 256. And the rest is neatly presented in the following table:

Wait a minute! Perhaps you had just better think about this and check it once again. There must be a mistake here. How can 1 Kbyte be 1,024 Bytes and not 1,000 Bytes? But do not worry, it is correct.

It is all due to the binary number system. As you know, binary numbers consist of ones and zeros, two different states. 1 KiloByte is  $2^{10}$  Byte, which is 1,024 Byte, but it is not at all uncommon that it is incorrectly called 1,000 Kbytes, when what is actually meant is 1 MB. So 16 MB RAM is really 16.384 Kbytes RAM.

## Take the bus to BIOS

There is a bus in a PC. It is actually a connection between each of the electronic building blocks on the motherboard (along with other things). So the name is correct enough. The processor – the boss – needs to have excellent communications with his employees, the other chips.

For this reason the motherboard is decorated with small permanent copper pathways. Now, a single pathway is nowhere near enough for the masses of data which needs to be transported. There are usually 32 paths lying next to each other, and if this is the case then we are talking about a 32-bit-data-bus.

But – again we are talking about zeros and ones, and as you might imagine this bus allows for the transport of 32 '0' or '1's simultaneously. The first chip which would support a 32 bit data-bus was the 386 processor. Only much older PCs work with a 16 bit bus. To really be able to exploit all these wires you need to use special **32-bit-software** like **Windows 95/98**.

The amount of capacity available				corresponds to
1 bit				0 or 1
8 bit	1 byte			a character
8.192 bit	1.024 byte	1 KByte		some lines
8.388.608 bit	1.048.576 byte	1.024 Kbytes	1 Mbyte	approx. 350 pages (approx. 1 Mill. characters)
	1.073.741.824 byte	1.048.576 Kbytes	1.024 Mbytes	1 GByte a small library (approx. 700 books of 500 pages each)

**fig. 21: Summary of available capacity and its name**

There are several different standards of bus systems (called bus architecture).

You will often see the term → **PCI bus** in advertisements. This special type of the fast '32 bit transport system' was developed by Intel and really began to be taken up when the Pentium processor was introduced. Nearly all new (IBM compatible) PCs are equipped with this bus type. A fast graphic card, however, needs the new → **AGP** port. This is an even faster bus type. But at the same time most new motherboards still support the classic → **ISA bus**.

Expansion cards which do not need such a high data transmission rate, such as sound cards, are attached to the usual 16 bit ISA places. Not even network or controller cards need all the speed which a PCI bus is capable of.

Up to a short time ago, the fast → **VLB bus** was very popular, but it was soon overtaken by the PCI bus.

This is the place to mention another building block, the computer's → **BIOS**. This is a little chip which sits on the motherboard.

It remembers information about your system, such as the type of hard disk you have, how much space is on it, how much RAM your machine has, what sort of processor it has and so on. The BIOS checks your machine when it starts up, checks the RAM, makes sure that the hard disk is working, that the processor is ready, and so on.

It is not so good if this chip forgets this data, so each computer has a little battery which supplies the BIOS with the energy it needs and also runs a little clock. This is the way that your computer 'knows' what the time and date is when you switch it on.

It is a problem if the battery runs down, and this can happen after three to five years. In this case older computer forget who they are and cannot start. Modern machines check themselves and don't trouble you at all. On most PCs you can go into the BIOS by pressing the Ctrl + Alt + Del keys together and holding the Del key down for some seconds. But be very careful, you can cause a lot of damage if you start altering the BIOS!

My tip is not to touch it at all, unless you know exactly what you are doing! You can find information about making alterations to the BIOS in books about upgrading a PC. KnowWare, the publishers of this booklet have published such a book. The precise method of adjusting the BIOS is dependant on its producer (Ami, Phoenix, Award) and the date it was manufactured.

If you have now had enough of the computer and all its little bits, then relax, you can do all sorts of things with it without having to know every little detail of its workings. That I can promise you!

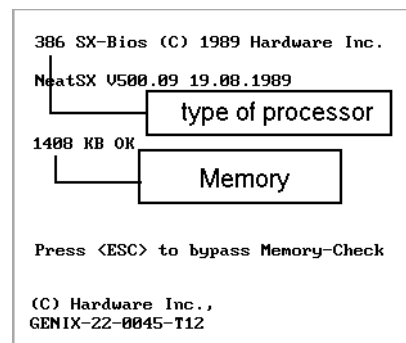

## Software - not so hard!

Most of what we have talked about up to now has been what is termed → **hardware** – the monitor, the cabinet, the keyboard and mouse etc. and components like the processor, motherboard and so on; they are all something solid you can hold in your hand. In theory everything you can take and hold is hardware, it is the ironmongery of the machine.

Hardware – is quite simply the apparatus itself. If you want to be pedantic, even the shortest little cable is hardware!

## Computers are stupid

In fact a computer, when you consider its individual parts, is nothing more than a mixed up collection of tin, plastic and silicon, with some more or less poisonous heavy metals thrown in. It contains some chips, some lengths of cable and printed circuits and some bits which go round and round. When you switch the apparatus on you'll hear the fan start, and that is actually it – unless there is some → **software** installed. Without software a computer cannot even be used for filling holes, making coffee or swatting flies.

But even in the days of mainframes, it was realised that to use them as enormous dust-traps was a huge waste of energy and money. So right from the start they were equipped with programs, the insubstantial software. The first computers were only really used for calculations. If a different type of mathematical problem had to be solved by ENIAC (see page 7) than the one it was ready for, then one was in difficulties. The 'programmers' did their job by hand, by moving leads around to where they needed to be, but it was not long before these programs could be saved. First on punch cards or punched tape, then on magnetic tape. Now the fast (magnetic) hard disk has become the standard, and for backing up and transporting data smaller magnetic disks are used, our good friend the diskette!

Today a quite ordinary computer can do a lot. You can use it to write, draw, manage data, send faxes, play music, compose,

play games – you can even use it as a 'surfboard' as we will see later.

And we owe all this to the people who have written instructions which the machine can understand. Often an entire team of sharp minds work for years to develop a program which can do the things we want – whether this be creating world beating animations and cartoon films with a few clicks, drawing an interior design for a new apartment or hunting small green Martians which are to be sent to silicon heaven with a virtual gunshot.

But before checking out office programs or games, we will just cast our eyes over every computer's most important program.

## The operating system – full throttle

The most important program in a computer is the → **operating system**. Without this system the machine simply cannot work. It makes sure that data is transferred within the machine, which means that if we copy a file from the hard disk to a diskette it happens via the operating system. Firstly bits and bytes need to be shared between the individual hardware components like the processor, expansion cards, monitor, printer, etc. Next programs, like a word processor, also need bits and bytes to be manipulated. If we want to write a letter using the word processor, it cannot be done without the help of the operating system – the letter has to be correctly displayed on screen, sent to the printer and so on. The operating system works like a theatre director, organising the correct display, a good printout and everything else which is necessary, co-operating with its colleagues the graphic card and the monitor. The operating system is a kind of basic program, the director behind the scenes.

This powerful program is loaded, or read into RAM by the computer during its start-up sequence. One could say that it is brought over from the filing cabinet and put on RAM's 'work table'. In computer language it is said that the computer → **boots**. This can take up to a few minutes, open the filing cabinet, close it again,



**fig. 23: DOS prompt**

The first thing you meet is the drive letter. C stands for your hard disk, A for the diskette drive. Other letters refer to further drives, like a CD-ROM drive. You type in your commands where the cursor is flashing.

Are you sitting comfortably? Let us look at the two most important keys you will use when using a computer. The first is the return or **Enter key**. This ends all commands, which means it is used all the time. The **Enter key** looks like this:



The other important key is the **Backspace** key, this deletes the character to the left of the cursor (which is our little blinking bar.)



The **backspace** key sits above the **Enter** key. On page 39 you will learn more about the keyboard.

Do you want to know what the time is? Write the command `time` at the DOS prompt, press **Enter**, and there is your answer. You can now either type in another time, or press **Enter** again if you are satisfied with the accuracy of your PC's clock.

You can activate and edit the date in the same way. In this case the command is `date` ↵

If you edit the date you should keep to the conventional method using two characters DD-MM-YY (day-month-year) – or MM-DD-YY on American machines. If the date is correct, then press **Enter**.

If you want to wipe the board clean – well, the screen in this case – then type `cls` ↵ and you will end up where you started.

A program is started by using its own special program command. For example, the command `word` ↵ starts the word processor Word (for DOS). Of course, for this to

work the program must be installed on your computer.

`dir` ↵ is a very important command which will display which files are immediately available. If you want to see what is on a diskette, then put it in the drive and type `a:` ↵

The contents of the diskette are now read in. Then type in the `dir` ↵ command and you can see what the files on the diskette are called.

⇒ Using Windows today means that you no longer have to learn these commands, but maybe you like controlling your machine in this way and want to learn more about your computer.

Up to a while ago MS-DOS was simply THE operating system – even when Windows 'decorated' it like a layer of icing on a cake, as we will see in the next chapter.

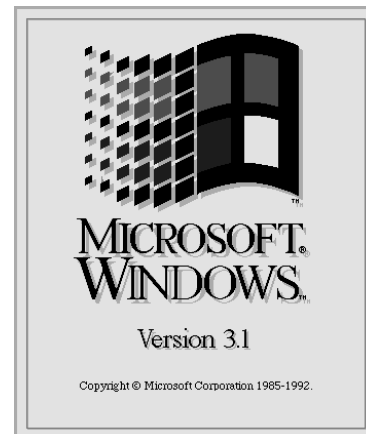
**Windows with colored symbols****fig. 24: Start-up logo in Windows 3.1**

Simple and spartan, no, the operating system of an IBM compatible PC could not continue like that. Even DOS users ought to be able to enjoy a comfortable user interface which made full use of symbols and pictures. A graphic user interface had to be the way forward. And so software developer Microsoft went to work to develop a special program for this purpose. In 1985 Windows was released, now world famous, but in contrast to the Mac's operating system Windows was not an independent system. It was installed on top of

DOS and still needed DOS commands. The first versions of Windows ran so slowly that very few people bought them, and as if that wasn't enough, there were hardly any programs which could work together with Windows, so of what use was a graphic user interface if there were no programs for it?

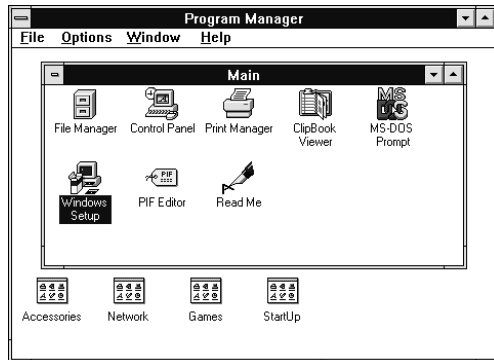

**fig. 25: graphic user interface in Windows 3.1**

It was first in 1990 that Microsoft broke into a larger market with Windows 3.0. Gradually it had begun to run stably, more surely and at an acceptable speed. In the meantime other programs: word processors (including 'Word for Windows'), drawing programs etc. which used Windows had begun to appear. Windows 3.1, released in 1992 really started to sell, and a little later version 3.11, which could set up several computers in a network, appeared. In the meantime more and more programs were being written for Windows. Basic DOS began to lose popularity and finally colored symbols, buttons and folders appeared on a DOS computer's screen. Already it became unthinkable to work without the practical mouse.

With Windows Microsoft immediately achieved a monopoly position, and today it is nearly impossible to find a computer which does not run it. The 'old Windows' was replaced by the even easier to use Windows 95/98. The idea of using the year number instead of a version number was a new trend.

Today there are many computers which run perfectly well with DOS 6.22 and Windows 3.1 or 3.11. This 'old Windows' is activated in DOS by using the `win` com-

mand (remembering to press **Enter!**) So let us compare DOS and Windows (Version 3.0). In the main the same applies for Windows 95/98, which we will look at later.

#### 🕒 Windows advantages:

- graphic structure, intuitive use, no commands to learn
- all applications (programs) run in what are called windows, or parts of the screen which can be altered in size according to need
- several programs can be run at the same time (→ **Multitasking**)
- program windows which are not currently in use can be placed in the background, but brought to the foreground at any time
- printer configuration is simpler. DOS required each program to configure the printer separately, but with Windows it is configured only once, then it is ready for use by every program.
- Windows has a simple file administration system which makes it easy to organise and order a hard disk, diskette or CD-ROM
- Windows contains many useful accessory programs: a mini word processor, a calculator, a notebook, games, etc.

### Windows drawbacks

- makes a lot of demands on the computer – needs a minimum of a 386 processor with 4 MB RAM, and Windows 95/98 needs much more
- a slow computer (less than a 486 processor) usually runs Windows programs slower than corresponding DOS programs
- Windows not only needs more RAM, but also a larger hard disk
- Windows crashes more often. i.e. everything stops and the PC does not react to commands.

As well as DOS there are a number of other operating systems. For example OS/2 was thought of as an alternative to DOS/Windows.

### OS/2, a better operating system

A couple of years ago I was talking to an American friend about computers. He had been an enthusiastic PC user for years and had taught me much about this miracle machine. When I told him about my first experiences with DOS and Windows he shook his head. "OS/2," he said, was "very good, just way cool, man!" His eyes lit up, and the computer expert from the land of unlimited opportunity became wildly enthusiastic. But what is the real truth about OS/2, and why does one hear so little about it?

In the beginning it was a common project for the two giants IBM and Microsoft. When OS/2 came on the market in 1987 it was thought of as DOS's older brother and replacement. Even the name said it all – OS/2, **O**perating **S**ystem/**2** (operating system no. 2). Of course it was a program for IBM computers – what else?! OS/2 had it all, everything a computer freak could desire: a graphic user interface (since 1988), high stability, support for 'old' DOS programs etc. Even the DOS commands could still be used. And as well as this you could move between several programs running at the same time, this was called → **multitasking**.

At the time, using MS-DOS this was simply impossible. With this a program first had

to be shut down before a new one could be started, and as well as this OS/2 exploited the possibilities in the (for then) new 286 processor much better, so that more than 1 MB of RAM could be used, and as we know, you can always use as much RAM as you can get hold of. All in all, OS/2 was basically just a better and more modern operating system. So what was the problem? Firstly there were the very high demands made on the hardware. If OS/2 was to run at a reasonable speed, it needed the best and most expensive machines. And the other problem was the program developers. Everybody wrote software for DOS and Windows, nobody bothered with OS/2, and of what use was the best operating system in the world if there were no programs for it? Finally there was a fight between IBM and Microsoft. These previous partners had become bitter enemies. The two computer giants competed bitterly with each other and were nearly at each other's throats. Microsoft gambled everything on Windows and won a pole position in the market, with the help of some brilliant marketing, and so it was of no help at all that IBM with OS/2 continued over the following years to be technically ahead of Windows. The following table shows some important stages in the development of OS/2.

Year	Event
1988	OS/2 gets a graphic interface.
1992	OS/2 becomes a pure 32 bit operating system (Windows first achieves this in 1995).
1993	by using an accessory, Windows programs can be run under OS/2!
1994	Version 3.0 (OS/2 Warp) released. A free bonus pack is also given away, this includes effective office programs
1996	OS/2 Warp 4 contains integrated voice commands. The computer can be controlled via a microphone.

**fig. 26: OS/2 – important stages**

OS/2 is first and foremost used by professionals. Large companies and banks still use it because of its stability. Home users took to it in 1994 and '95 and especially in

Germany, IBM Europe found itself with a success on its hands. Contracts with large discount computer chain stores meant that many PCs were delivered with OS/2 pre-installed.

Today Windows is sold almost without any competition. Rumour has it that IBM has given up any further development of its 'better operating system' – unfortunately.

### Unix for the Net

Another operating system, Unix, although actually of no interest for the home user is very important in the professional world. In universities especially this development of a 1960s operating system is much used and is the system of choice. It is an 'open system' freely available for everyone and there are several different variants available. Because most computer and programming experts start getting experience and take their first steps at university it is natural to take their (UNIX) experiences with them into the commercial world.

Unix's greatest strength is its network abilities. Unix lets many computers be connected to each other without problems, no matter if they are mainframes, medium sized machines or ordinary PCs. And this is what makes UNIX interesting for people who work a lot with the → **Internet**. At base this is nothing more than a large network. A world-wide collection of computers which are connected to each other. More about this on page 51.

### fig. 27: Linux using 'X-Windows' (section)

There are several different user interfaces for Unix, X-Windows being one. A slightly more humble variant, called **Linux**, is even given away free for private use. If you own a copy of Unix or Linux it is often possible to find free programs for it.

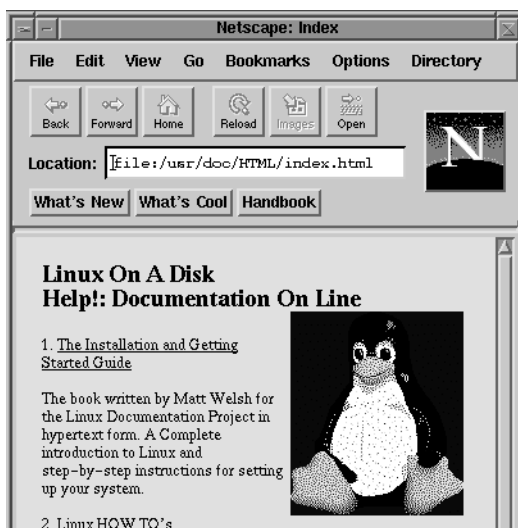

## Mac OS

'Wow, how easy it is', exclaimed a secretary when I recently showed her how simple it was to copy a file on a Mac computer. The file is simply grabbed with the mouse and dropped onto a small folder – and there it is, inside it. When my colleague found out that to delete a file all that needed to be done was drop it in a wastebasket, her jaw dropped in amazement.

The present version of the Mac operating system is simply called System 8. System 7 came into use in 1991, before then it was System 6 and so on. Somewhat of an understated name for the most classic of operating systems when it comes to intuitive and simple use! Names like *Gem* [a graphic DOS interface from Digital Research], *Windows* [Microsoft], *Presentation Manager* and *Workplace Shell* [IBM for OS/2] or *Solaris* and *X-Windows* [graphic interfaces for Unix] in contrast sound much more meaningful. Though the Mac operating system is also called MacOS.

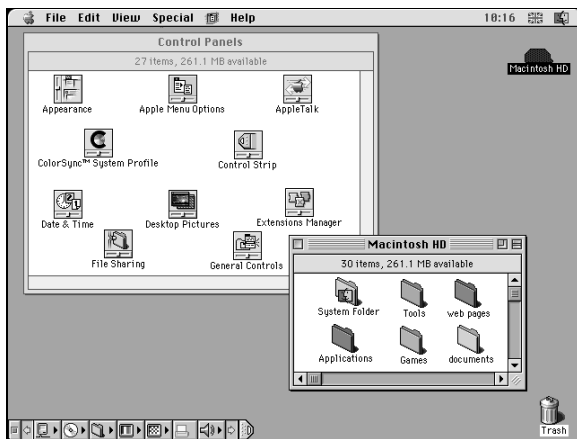

**fig. 28: the famous Mac interface – version 8**

There is no longer any reason to choose a Mac because of its simplicity of use. Windows 95/98 offers the maximum of easy use, even though it is no more than a 'copy and loan' of other systems. Today most programs are written for Windows 95/98 or higher versions.

## Novell Netware and Windows NT/2000

The software company Novell created great attention for itself as early as the 1980s with its network operating system. Novell Netware is used first and foremost when many computers are to be connected together. This system works without problem together with DOS, Windows, OS/2 and even with Apple Macintosh. Until recently Novell was the clear market leader in this area.

Windows NT is Microsoft's answer to Novell Netware. This system is a very advanced professional operating system and less designed with the home user in mind. One might think that the name NT has something to do with networks, but it actually stands for New Technology. Windows NT is a powerful, RAM hungry and resource craving operating system with high stability. It is not so good for 'trivial' pursuits like games, multimedia etc. Windows NT is available today as version 4.0 and Windows 2000 and its interface is very similar to Windows 95/98.

## Driver – a kind of miniprogram

The operating system is necessary for the computer to run, but if you want to use the machine for anything useful you will need several programs: a word processor to write with, a painting or drawing program to paint or draw with, a calendar program to remember appointments, a home economics program to plan your finances, a calculating program or 'spreadsheet' which lets you see the size of your overdraft using multicolored charts and so on. Further on in the booklet we will see what exactly we can do with some of these different programs.

Fewer realise that even the basic operating system actually consists of several programs. Each hardware component needs its own mini-software. When I buy a new graphic card then the box includes not just the card, but usually also a CD or diskette with the special software which runs that component – or it will not run efficiently, or maybe not at all.

Similarly every printer needs its own little mini-program, a 'driver' for it. These spe-

cial programs are called just that, a → **driver**. The Windows 95/98 operating system comes with the most current drivers from all the best known producers, but driver software is continually being improved. Mistakes need to be corrected, new options have to be available.

When I invested a couple of years ago in an (expensive) sound card produced by the Miro company I was completely taken in by the packaging. The box showed a tiger, and the card looked so impressive, glittering like gold, but it took a lot of hard work to get this costly piece of hardware to make any noise, and as if that was not enough it crashed the machine every time I wanted to play a piece of music. When I upgraded to Windows 95/98, the card finally lost its tongue completely. Finally I managed to get hold of a new driver, but it was so bad that my expensive sound card sounded no different to the cheapest discount model.

On the other hand I was very satisfied with my graphic card. The producer was well spoken of, not just for their components, but also for the driver software which came with them.

The examples illustrate that even in the computer world things should be taken with a grain of salt. Like any branch it consists of people with lots of human failings, even though the packaging can be very attractive.

Programs, software. There is one question we have not answered yet: how are these electronically coded work horses actually stored on a storage medium?

### File types and organization

The following section is all about files. Let us return to the hard disk, the storage device which is a part of the PC. On page 19 in the chapter *Sending documents to storage* we found out that files can be permanently stored on the hard disk. This is where programs are kept, and here (or on a diskette) that the produce of our hard work should be saved for all eternity. But how, and where?

### Document files

Let us just get one thing straight: Nearly everything which you can create with a PC can be saved as a type of file – a letter as a text file, a picture as a graphic file, a piece of music as a sound file and so on. If you save your masterpiece as a file it will be taken from the working memory, RAM, and saved on the hard disk – or on a diskette if that is the case. The **Save** command is the most important command there is when you are working with a PC. I have called the file which contains this booklet `round`

My word processor automatically adds a little extension to this name, so it ends up being called:

`round.doc`

This extension is what could be called the file's family name. This shows that the file has been created using the program *Word*. The file name and the extension are separated by a point which is set in automatically. A drawing made using the painting program *Paint*, which comes with Windows 95/98, is automatically given the extension `bmp` – standing for bitmap, simply a 'pattern of bits'. This is a type of picture file which saves pictures as a collection of many single points or pixels. The following table shows a little selection of typical file extensions. The star takes the place of the file's name. Windows 95/98 usually hides the extension of a file.

Extension	File type
*.txt	text files
*.doc	<b>Word documents</b>
*.wpd	WordPerfect documents
*.xls	Excel tables
*.bmp	<b>pictures in bitmap format</b>
*.wmf	pictures in Word format
*.mid	Midi-files (sound, music)
*.wav	Wave files (sound)
*.bak	backup copies (usually produced automatically)

**fig. 29: selected document file types**

So a file is recognised by its name, a point and a characteristic extension.

## Program files

But even software programs consist of different types of files. These contain the program's code, language the machine can understand. For a usual user most of these program files have little interest, because there is nothing one can learn from their contents, unless one has learnt programming. But this is not necessary, you can appreciate the most fantastic video film without having the slightest idea of what a video recorder looks like inside.

But there is one type of program file which is worth looking a little closer at. The start file, or executable file. After all a program needs to be started in some way or another, just like a video machine has a Play button. A start file can usually be recognised by its extension:

exe

This comes from the word execute, in the sense of 'doing'. All programs have at least one 'exe file', but there can often be several. For example the 'Word' word processor is started using the file

winword.exe

But as a user you will not really notice this. The file is automatically activated in the background, when you click on a symbol or on a button. Only when using DOS was the start file name also the command for starting the program.

But before a program can run it needs to be installed. This means it should be copied from the CD or diskette to the hard disk and set up in the correct way. As well as this, the entire package is usually compressed to take up less space, but one file will always be available, a start file. This will usually have one of two names:

setup.exe / install.exe

Double-clicking on this file in Windows 95/98 Explorer, for instance, will start a program which will install the program. This sounds a little strange ...

And by the way, some (smaller) programs can be run directly from a CD.

Extension	File type
*.drv	driver (small program)
*.ini	initialization file
*.hlp	help file
*.exe	<b>start file for a program</b>
*.com	start file for a program
*.bat	Bat(ch) file (for starting programs)

**fig. 30: selected program file types**

File names follow some very strict rules. With DOS and the 'old' Windows only eight characters could be used, and spaces, points, and a number of other special characters were strictly forbidden. A letter to aunt Edith must under

**no circumstances** be called :

letter to aunt edith.doc

but

edith.doc or aunt-ed.doc

(because of the 8 point 3 rule).

Luckily using Windows 95/98 this irritating 8 point 3 rule is no longer necessary! A file name – without extension– may now contain up to 255 characters. And the Mac has always been able to cope with long file names!

## Trees which grow down into the ground

We are beginning to be comfortable with storage media, they are each distinguished by a letter . And while reading the last couple of pages you should have become good friends with document and program files. But how exactly are these files and all the data stored?

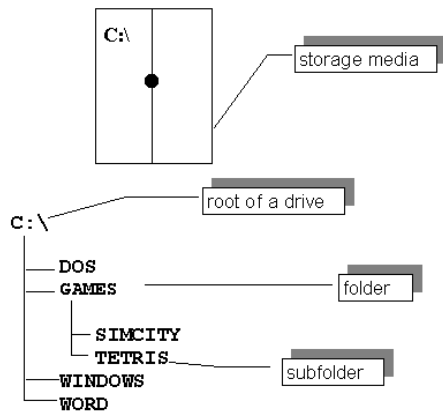

**fig. 31: Directory tree on the hard disk**

In theory you could just throw all your data directly on the hard disk `C:\` – open the cupboard, chuck it in – a quick job and complete chaos! So for precisely this reason a storage medium is divided up into directories or folders, which you could think of as draws in your cupboard. The amazing thing is that each drawer can contain ‘subdrawers’, called subdirectories (or subfolders), which can also contain more subdirectories and so on.

These directories can contain almost an infinite amount. Starting at what is called the first directory, called the root directory, a whole tree can grow, called a directory tree. One further thing, in Windows 95/98, directories have been renamed to folders. Old wine has been put into new bottles!

Programs are usually given their own directory or directories on the hard disk. Windows, for example, lies in a folder called `Windows`. This `Windows` folder has several branches. The Word program is installed in its own folder called `Word`, and so on.

When you choose the **Save** command you choose which folder you will place your file in. So it will really pay dividends if you create a clear structure of directories. Every operating system has its own command for creating directories and sub-directories. Accessory programs called File managers help administer these directories and their contents, and can also be used for creating sub-directories. One of the best known file management programs for

DOS is **Norton Commander**, which is also available as a version for Windows 95/98. Windows 95/98’s file manager is called Explorer.

We will look closer at it on page 38.

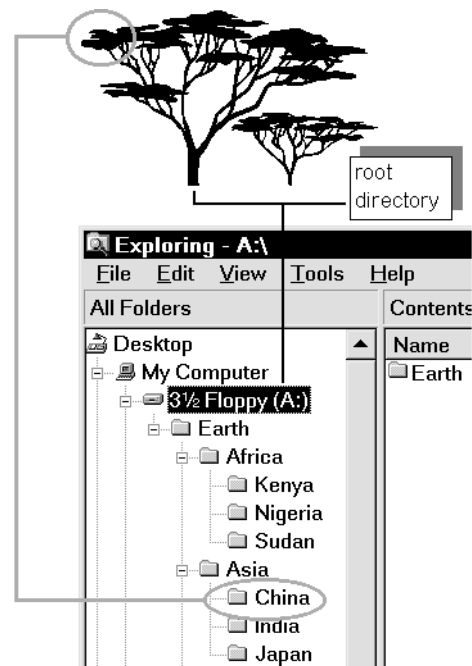

**fig. 32: Structural organization of a diskette**

This screen picture was taken using Windows 95/98. It shows the structured organisation of a diskette (drive `A:\`) into sub-directories. When you buy a diskette it only contains one directory, the root directory `A:\`

⇒ The picture clearly shows why we talk about a directory tree.

With Windows 95/98 everything has become a little clever or a little more colorful and a little less complicated. Let us look at the current Windows versions and open a window to the world.

## Windows 95/98 - A window to the world

It was a close run as to whether Microsoft would get this celebrated software finished in time, but in the end they just managed it – in the autumn of 1995. Windows 98 was shipped in June 1998. There are no major differences between the two versions, at least from the surface. Windows 98 needs a more powerful computer and comes with a built-in Internet-Browser. Windows 95 became a best seller almost immediately. When you buy a computer today it will probably come already installed with Windows 95/98.

Windows works with a collection of windows. Each program runs in its own window, which can be adjusted to different sizes. A window on the world also means that Windows 95/98 lets you get on the → **Internet** without any problem (more on

page 51). When you switch on your PC, Windows starts and what is called the **desktop** appears, but there are no windows open yet.

The Desktop is your working area, which you can arrange as you want. From here you can start the most important programs. **My computer** gives you a view over your storage media. The most important button is the **start button** in the bottom left hand corner. Clicking on the **Start**, pops up the **start menu**. All your other software can be run from here. The start button sits on the taskbar. This is always on the screen and shows which programs are currently running. It is a kind of command centre.

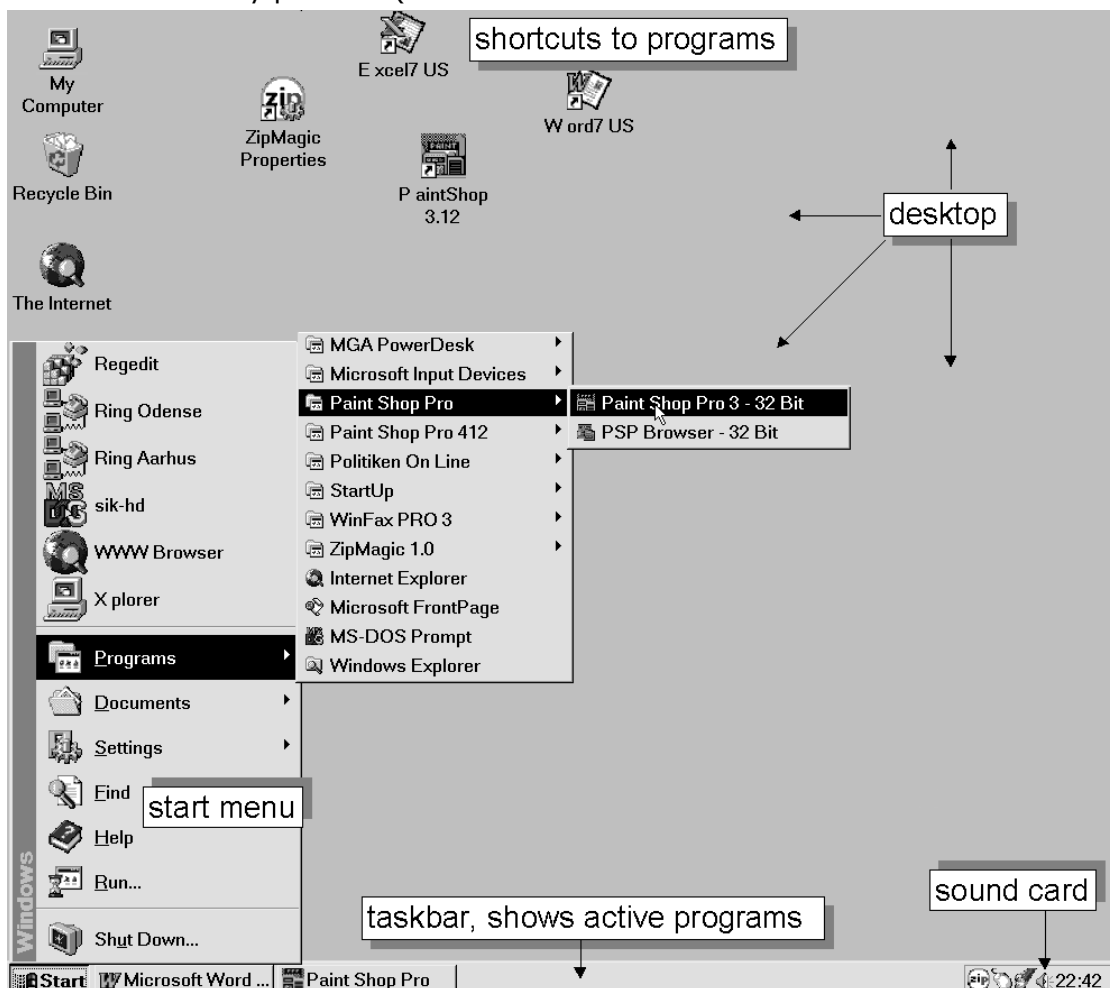

fig. 33: Windows 95/98 interface – the Desktop

## Something borrowed...

'Hallo', I thought, the first time I played with Windows 95/98, 'this is just like a Mac'. I had just studied the Mac's System 7.5 very thoroughly, and yet again Microsoft had once again 'borrowed' from another producer in a rather unsubtle way. So Windows 95/98 can now show off its 'trash can', only it is called a Recycle bin, for deleting files. The Mac has had one for more than ten years!

A directory is now called, as on the Mac, a folder. Windows can now manage long file names, and if you want to give a file a new name it is done in exactly the same way as on a Mac – you click on the file name, hold the mouse button down a second and then overwrite the old file name with the new. Apple's operating system was not the only inspiration for Windows. Other graphic user interfaces were also used as sources, like OS/2 and some Unix variants.

Well, borrow whatever you can get away with. That, at any rate, seems to be the solution used by a large proportion of the computer industry – just look at the number of court cases where firms blame each other for breaking copyright laws.

But Microsoft has taken the best elements from every system – and adapted a lot of them so they are different and better.

## Start with Start

And there is no doubt that Windows 95 incorporates some good and practical improvements, but there was more than ten years research and development behind it. Every little detail was tested in laboratories especially designed to test how easy a program is to use, called 'Usability Labs'.

Every mouseclick was tested, every button checked to see how intuitive it was to use. Things which put beginners through agonies in version 3.1 and 3.11 are no problem in Windows 95/98. For example, Windows 3.1/3.11 would allow a program to be started several times – one simply did not notice that a program was already running in the background. However Win-

dows 95/98 shows active programs neatly and obviously as buttons on the Task Bar, which like the Start Button is always visible.

In our example on page 33 Word and the graphics program Paint Shop Pro are running in background. If I want to continue working with Paint Shop Pro, all I need to do is click on the button.

If I want to switch back to Word, then I just click on another button. A stroke of genius! If I want to activate another program, then I click on **Start** and point at **Programs**.

An extra menu pops up, though it does take a little time to get used to these menus which suddenly appear. When I have found the program I want, I just click on it, which starts it up and the Task Bar gets another button. The number of programs I can have open is totally dependant on the amount of RAM installed. An illustrated guide and exercises to Windows follow in our lightning course to Windows.



**fig. 34: Start button – the most important element**

The **Start** button is one of the smartest things with Windows. As it is visible on screen all the time, it is easy to open new programs. The Start button is simply always at hand.

Even help can be started via **Start – Help**. And though it may sound bizarre, the Start button is even used to close Windows down: you click on **Start** and choose the **Shut down** command, and after a final confirmation click on **OK**, Windows closes.

## The great Windows comparison

So, you want to know more about Windows and are interested in all the technical stuff? OK, the following table shows the most important parts of Windows 95/98. To make it all as clear as possible, you can compare it with the 'old' Windows.

Windows 3.1, 3.11	Windows 95/98
Vintage 1992	Vintage 1995/98
an accessory to the operating system, cannot work without DOS	an independent operating system, though it includes its own DOS
written in 16 bit code, meaning that options available in newer processors (386 on) are not fully exploited.	(mostly) written in 32 bit code, so can exploit all options available in newer processors (386 on).
new 32 bit programs cannot be run (Word 95, Word 97/2000, Corel Draw 7 etc.)	new 32 bit programs written specially for this operating system
relatively low hardware requirements	high hardware requirements
runs reasonably fast, even on old PCs (from a 386 DX 40 with 4 MB RAM)	only runs well on PCs from a 486 DX 40 with 8 MB RAM, Windows 98 needs at least a 486 DX 66 with 16 MB RAM.
relatively user friendly	even more user friendly
'8 point 3' DOS rule for file names : br-mofie.doc	allows long file names, including several spaces like. letter to aunt Edith.doc
crashes relatively often	rather more crash-proof
right mouse button unused	right mouse button opens a popup menu, called the object or context menu.
does not automatically recognise new hardware	Plug&Play – automatically recognises newly installed hardware
Internet and e-mail functions not integrated	integrated Internet and e-mail functions
fax function first added with version 3.11	integrated fax function in Windows 95 only
reasonably good Multimedia functions	better Multimedia support
Only network ready from version 3.11 (Windows for Workgroups)	unlimited network support
extensive accessories with word processor, drawing program (Paintbrush), calculator, mini-database and games	more developed accessories with Word compatible word processor Wordpad, painting program Paint, calculator, games, communications program and utilities for checking storage media

### Lighting Windows course

Due to the limited space available here we will just go through a very quick and compact course which will simultaneously cover both Windows versions.

### Starting a program

Both Windows versions let you start a program with a few mouse clicks. The method is actually very different in Windows 95/98 than in the older versions, but with the new 'pop-up' menus it is easy to see where you are. No more words – let us start with the course.

### Windows 3.1/3.11

1. Double-click on the group symbol containing your program.



2. then double-click on the symbol representing the program you wish to start.



**Windows 95/98**

1. Click on the -button, and the **Start** menu pops up.
2. Point at **Programs...**



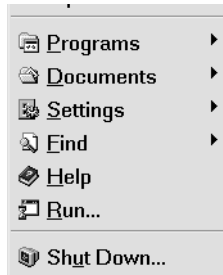





and then at the program group containing the program you want ...
3. and then click on the program you wish to start



**Tip:** Move the mouse horizontally and vertically, not diagonally, or the pop-up menu will disappear before you are able to click on it.

**The behaviour of the common window**

As stated, each program runs in its own window, a part of the screen. These windows can be moved, maximized and minimized, even turned into an icon just as you want. They can even be placed on top of each other. The window you are working in is called the active window. It has a blue title bar where you can see some buttons, mainly on the right hand side. Let us take a closer look at these tools for controlling your windows.

Win 3.x	Win 95	action
no		<u>close</u> window (close program)
		<u>maximize</u> window
		<u>minimize</u> (in Win 95 the window becomes a button on the task bar)
		<u>resize</u> window. that is make a smaller window (this symbol is only shown when the window is maximized)
		<u>system menu</u> . opens the system menu (typically an icon representing the program in Windows 95/98, a minus sign in Windows 3.x)

A click on the system menu button opens the **system menu**. These commands (close, minimize, restore) let you control your windows. These commands are the same as the buttons for controlling your windows shown in the table. The **Menu bar** contains a menu with commands for doing things with the program itself. The most important are integrated as buttons in the **toolbar**. The idea is to let you work completely intuitively. Instead of opening a menu and clicking on a cryptic command I would rather trust a (colored) button. And many programs show a little information label if you let the mouse hover for a second or two over a button. The **Scrollbar** only appear when the window contains more than it can show, in other words when it is too small. The **status**, or **information line**, is found, in some programs, at the bottom of the picture. It contains useful information.

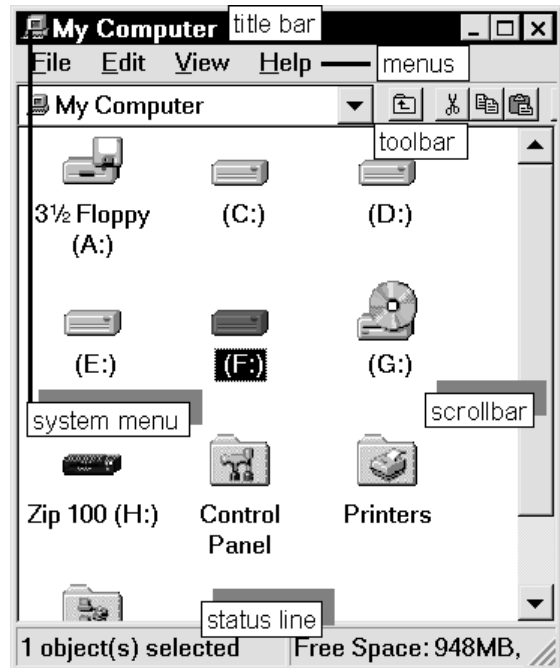
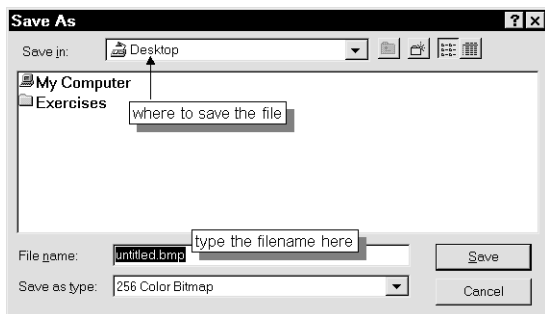

**fig. 35: a typical program window**

## Save

You have worked with a program, Paint, let us say, and now you want to store your masterpiece. All programs have the **Save** command in the **File** menu. And you will often find an equivalent button. This is what you do:

1. Choose **File/Save** (or click )
2. The following dialog box is displayed:



**fig. 36: The 'Save as' dialog box**

3. Now type in the file name. This will overwrite the *marked* name which the program has already put in, in this case `untitled.bmp`.

**Tip:** You do not need to type in the point and the extension, this will be automatically added by the program, and is often not used by Windows 95/98, as I mentioned on page 27

4. Next you should choose where you will save the file, the first offer is the Desktop.

**Tip:** To save your work in another folder and/or on another drive, first click on this

arrow  and then choose the folder and drive you want by clicking and double-clicking. When you are there, it will be shown in Save in.

5. Click on the **Save** button (or press **Enter**).

Now the file has got a name, and next time you save it the **File/Save** command will be carried out automatically!

**Be careful:** The 'Save as' dialog box looks slightly different in Windows 3.1/3.11.

## Closing a window

The easiest way to do this in Windows 95/98 is to use the **Close** button (the one with the **x**) in the window's top right hand corner. In Windows 3.1/3.11 double-click on the system menu button (the one with the small minus sign). If the window contains a program, this is closed at the same time. Don't forget to save your work. *Programs* can also be closed using **File/Exit**.

## From desktop to Recycle bin

**My computer** in Windows 95/98 is a very useful thing. If you want to see what your hard disk, diskette or CD-ROM contains, double-click on this symbol:

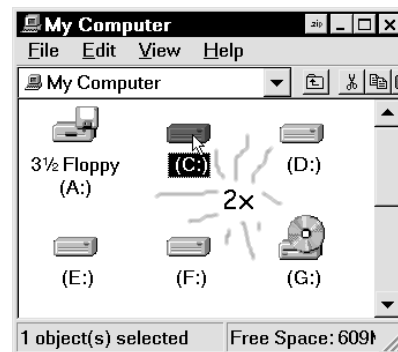

**fig. 37: My computer**

Let us say that I want to see what I have actually put on my hard disk. A double-click in the right place takes me where I want to go: a new window opens and I see a number of yellow folders and colored files.

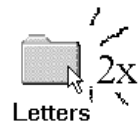

Here is `Letters`. Maybe I should tidy up this mess a little. What is in `Private`? Double-click – aha, a new window. `Letter to Anna` – that is ancient, I really ought to delete it. Using → **Drag & Drop** – and with tears in my eyes, I throw the letter in the Recycle bin. Drag & Drop is one of the most important techniques in Windows. I click on the letter, hold the left hand mouse button down, drag the file to the Recycle bin and then release the button, dropping it there.



## Out and explore with Explorer

Explorer is Windows 95/98's file manager. It is activated using **Start – Programs – Windows-Explorer**.

The left hand side shows the storage media's tree like directory (folder) structure (see page 29). A click on the small plus sign opens further branches. On the right hand side you can see the contents of the marked folder which you have clicked on. With My computer or Explorer (File manager in Windows 3.1/3.11) you can also create new folders, rename a file, sort files, open them and so on.

Even a program can be started from here, with a double-click on its .exe file (see page 30).

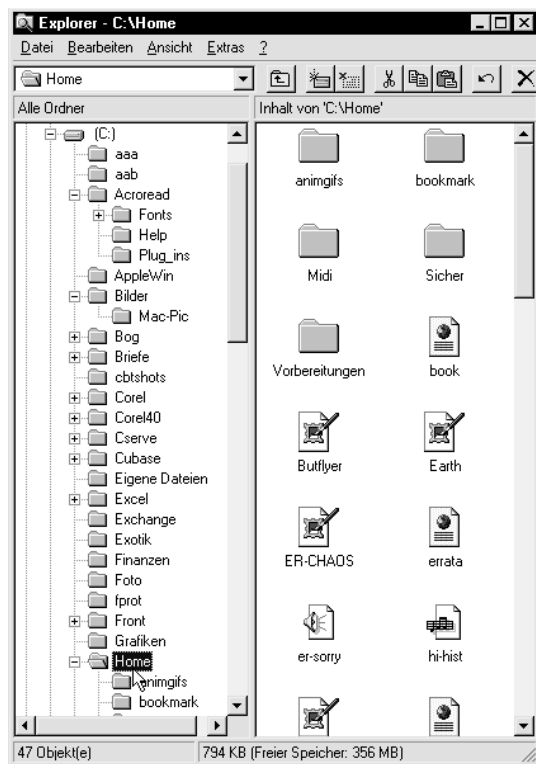

**fig. 38: Explorer, a kind of file manager**

## The PC as a typewriter

The most used programs on a PC are those for writing, known as word processors. Microsoft chief Bill Gates uses the term 'killer application' to mean a program which has helped create the enormous popularity of the PC. The best known word processor is Microsoft Word, now available in version 97. In my opinion Word is an excellent program, despite some faults (see also page 60).

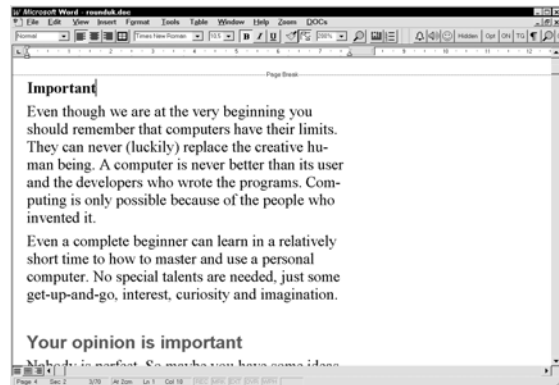

**fig. 39: modern word processing**

Windows 95/98 even contains an integrated word processor, called Wordpad which is actually Word's little brother. Click on **Start - Program - Accessories - Wordpad** to start it.

In theory you can now just start writing at that point where the little cursor is blinking in the window, but remember that in a word processor you just keep writing when the line fills up to the end. This means that there is no need to press the **Enter** key.

If you want to delete a character to the left of the cursor, when you have made a spelling mistake for instance, then press the **backspace** key. The key marked **Del** deletes characters to the right of the cursor. If you want to add something to some text which you have already written, then click on the place where you want to insert the text and the cursor will appear there. You can do the same with the arrow keys, which you are about to learn.

## A little keyboard abc

Look down at the keyboard in front of you! The **Enter** key is not just used to make a new paragraph – you also use it to confirm commands. Just as important is the **Escape** key at the top left. Escape in computer program means you get another chance, and this key can really help get you out of some critical situations. The **Shift** key switches between upper and lower case letters, or between the different signs on other keys. The **Alt Gr** key is not on all language keyboards, but if it is on yours it will let you type a third sign from some keys. It is the same as using the **Alt** and **Ctrl** key together.

The **Ctrl** key (control) is used in combination with other keys for specific commands. For example **Ctrl+Z** used to undo an action. The **Tab** key (tabulator) moves the cursor a predefined number of spaces to the right. The function keys have different uses, but **F1** activates the built in (online) help function in nearly all programs.

The block of arrow keys mainly contains keys for moving the cursor around. The simple arrows move it in steps in the direction shown by the arrow. The **Page up** and **Page down** keys move the cursor a whole screen up or down, assuming that you have written enough text. The **Home** key moves the cursor to the start of the line, the **End** key to its end.

The numerical keyboard has come from a calculator and is used in the same way. Many modern keyboards also include the **Start** key, which activates the start menu.

## Delete, paste, move

– there is no problem carrying out any of these operations, even in the most simple word processing program. Do you want to move a word? First you will need to select (or mark) it. This is done by dragging the mouse over it while holding down the left mouse button. The word will be colored black. Now click on the menu bar **Edit – Cut** or choose the button with the scissors. No need to panic, the word has not disappeared, it is actually stored in a kind of 'buffer zone', the Windows Clipboard. Now place the cursor where you want to paste in the word. **Edit – Paste**, or the button showing the clipboard and piece of paper, will do the job for you. You can copy a word or entire passage of text, in exactly the same way. But in this case you do not cut the text out, but let it remain in its original place.

**Be careful!** In most programs pressing the **Del** key after you have marked one or more pieces of text will delete these marked passages.

## The final touches

First select, then format, that is the order. If a word should be in **bold** letters, then you mark it and click on the appropriate

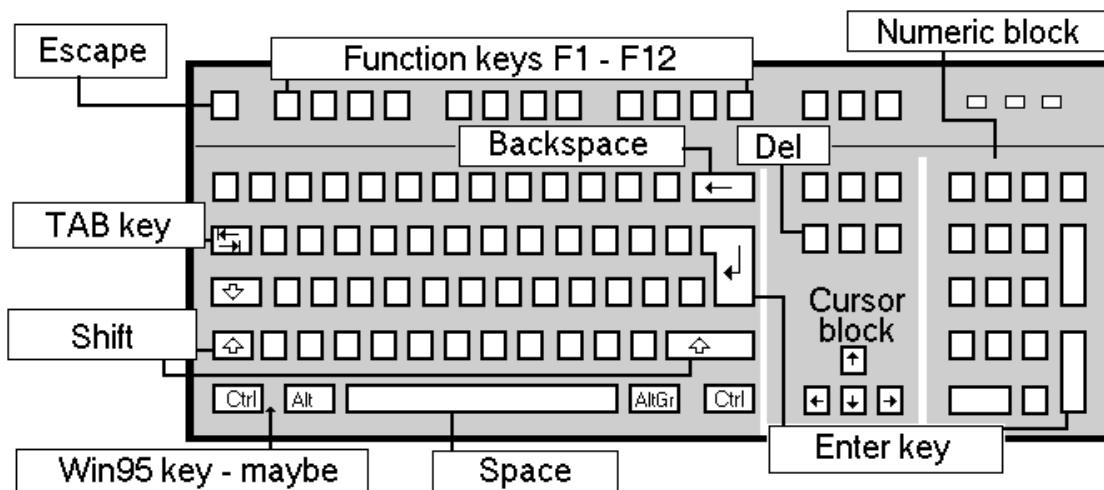

fig. 40: a standard PC keyboard, known as the MF II keyboard

symbol on the toolbar. Passages of text can be underlined or turned to *italic* in the same way.



**fig. 41: Formatting toolbar**

Even the font (the style of letters, like 'Times New Roman' or 'Arial') and their size can be altered to nearly anything you want. With the correct command you can also change the color of a word or the distance between the lines.

There are many commands to format text, precisely what they are depends on which program you are using. Generally there will be a menu called **Format** with a submenu named **Character** or **Paragraph**. The toolbar will probably only show the most important functions.

### DTP on a PC

Desk Top Publishing – producing books, magazines or brochures from a PC – is a common buzzword these days. Admittedly, most 'professional' layout artists mainly use special, and very expensive, programs like Aldus PageMaker, Quark Xpress or Ventura Publisher, but every word processor of note, whether it be Lotus WordPro, Corel WordPerfect, Softmaker TextMaker or another is a powerful 'DTP talent'. There are also a number of cheap, though highly effective DTP programs, like Serif's 'PagePlus' and Microsoft's 'Publisher'.



### fig. 42: real DTP – text flowing around the picture

Using this sort of software lets you create excellent multi-columned in-house newspapers, place pictures within the text, lay out books, define headers and footers and much more. Some programs allow for text to flow around a picture, a function normally only found in 'real' DTP programs. This booklet has been entirely written and laid out using Word 7.

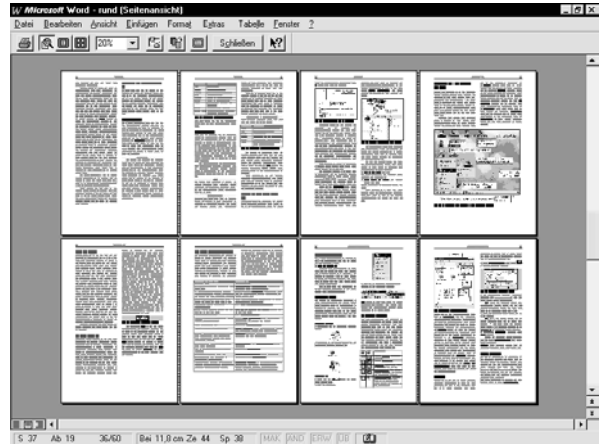

**fig. 43: DTP with Word**

And I nearly forgot – spell checking is, of course, included in every major word processor.

### Calculating in tables

Next to word processing, spreadsheets are one of the most useful types of program. Spreadsheet – that sounds very strange. A friend told me a couple of years ago that a spreadsheet was something to do with mathematics, and that was enough to make me lose any interest in that sort of program.

But that was stupid, because a spreadsheet is much more than a pocket calculator. It is actually fun to use. It can, not only calculate, but also plan, manage things, draw graphs, work out your mortgage, write a list, make sense of your accounts and so on, and it is not particularly difficult to use. A sheet makes it easier to organize formulas and so on, and that's

how this type of program was given its name.

The very first spreadsheet was developed in 1978 and was called VisiCalc. The best known program now comes from Microsoft and is called Excel. The most common used to be version 5.0 for Windows, but since then a version 97 and 2000 has come on the market. Other programs like Corel Quattro Pro, PlanMaker from Softmaker and Lotus 1-2-3 also have their place on the market. In most instances working with the different programs only differs in details. Some examples shown here are from StarCalc, a nearly perfect Excel clone.

### Numbers in cells

When you begin a spreadsheet, you see, funnily enough, an empty spreadsheet – a huge table. The small boxes, called cells, are not square, but rectangles, and are the foundations of a spreadsheet. This is where you enter your numbers, or letters if you want. It makes no difference which cell you begin to work with. When you want to move down to the next cell, use the mouse or arrow key. Every cell has its own address. If a number is in column B, row 3, then its cell address is B3, if it is one cell further down, then it is called B4.

An example: I want to find out what result  $1+1$  gives. So I type the number 1 in a cell, any cell. In the example I have chosen cell B3. The cell immediately underneath also has a number 1 typed in, and the cell under B4 will show the result. So I select cell B5 by moving down to it. Most programs have a 'sum' or 'autosum' button to add numbers together. This button probably looks like an equals sign and will be in a different place in each program. This sum allows an *autosum* to be calculated. Click on it, and there you are, the program checks out which columns or rows contain something which could be added together. Then it suggests a formula which can be seen in what is called the formula line. In my example the program has suggested, logically enough, the formula **=SUM(B3:B4)**. The value in brackets, called the argument, defines the

cell areas. The colon does not mean divide, but from/to. A final click on the button with the little tick (or press Enter) accepts the formula and displays the result – surprise, surprise: 2. If I now substitute another number, like 3, for one of the '1's, then this miraculous program automatically finds the correct result.

### Sales tax and averages

Everything can be calculated with a spreadsheet – from the possible to the impossible. For example the interest on a loan with a fixed repayment period, or the growth of a bacteria culture. But in general the majority of calculations can be carried out using the most basic functions. Firstly the result cell is filled out with the required **formula**.

Of course, you do not just write  $1+5*13$ , but instead of numbers you write in the appropriate cell addresses, like  $B5+B6*C5$ , and there is one thing more to remember, every formula starts with = Confirming the formula causes the result to be shown automatically in the cell. The formula is now visible in the formula line and can be edited.

**Be careful!** In some programs, like Lotus 1-2-3, a formula begins with @ symbol.

Calculation	Key	Example formula
add	+	=A5+A6+A7 or =SUM(A5:A7)
subtract	-	=C8-C9
multiply	*	=C3*D11
divide	/	=E24/E25

In the following example we will use two of the four mathematical functions to calculate sales tax and the gross price. We have the net price of packs of various types of beer. Sales tax is (in Denmark) 25%. The following table will do as a starting point, so write it down!

	A	B	C	D
1	Beer type	Net	Tax	Gross
2	malt beer	1.05		
3	bitter	0.96		
4	stout	1.05		
5	low alcohol	0.96		
6	pilsner	0.92		
7	premium	0.96		

We type one of the following formula in cell C2, and confirm it by pressing **Enter**:

**=B2\*25%** or **=B2\*0,25**

The result 26.75 pence pops up in cell C2 and can always be corrected to two decimal places after the point.

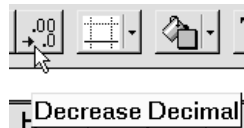

This can usually be done with a button which removes decimals. In this case we press the button twice, which gives a corrected value of 26 in cell C2. Now all we have to do is wish that a 6-pack of beer was actually so cheap...

Most programs will let you just copy the formula into other cells. In Excel and StarCalc this is done by clicking in the bottom cell's right corner, turning the cursor into a cross.

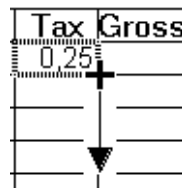

Now hold the left mouse button down and drag downwards, and the formula is copied to the other cells. And the cell addresses will automatically be adjusted, so that our formula to calculate sales tax on bitter in the cell underneath will be correct:

**=B3\*0,25** or **=B3\*25%**

So here we are talking about relative cell addresses.

In cell D2 we type in the simple addition formula: **=B2+C2** and confirm it. Voilà – a pack of malt beers costs £1.31. When we copy this formula downwards, we end with the following result:

	A	B	C	D
1	Beer type	Net	Tax	Gross
2	malt beer	1.05	0.26	1.31
3	bitter	0.96	0.24	1.2
4	stout	1.05	0.26	1.31
5	low alcohol	0.96	0.24	1.2
6	pilsner	0.92	0.23	1.15
7	premium	0.96	0.24	1.2

Working out an average is just as exciting. So let us imagine that a teacher wants to see how well class 5A does in its work and work out some statistics for marks. She does this by using the formula **=AVERAGE(.)**. In cell B6 she types (and confirms) the following:

**=AVERAGE(B2:B5)**

	A	B	C	D
1	Pupil	Exercise 1	Exercise 2	Exercise 3
2	Michael	11	7	13
3	Susan	8	11	6
4	Peter	8	8	8
5	Mary	13	13	11
6	average	10	9.755	9.5

She also wants to produce a graph to make the numbers a little more understandable.

She marks the first row of the exercise (B1 to D1) and then the row with the average values. (B6 to D6). Cells which are not next to each other are usually marked by holding down the **Ctrl** key while you mark them.

When the appropriate cells are marked, the 'Chart Wizard' guides our teacher making a graph. This is begun by using the menu Insert, Chart or the equivalent button:

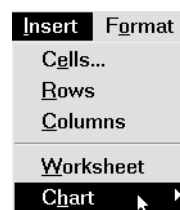

or

The mouse pointer now turns into a cross which is dragged over the area where the graph should appear. Remember to hold the mouse button down! Then several dialog boxes have to be clicked through, exactly which depends on the program used. The Wizard will usually find the best options itself. In the case of the school exercises it suggests a column chart.

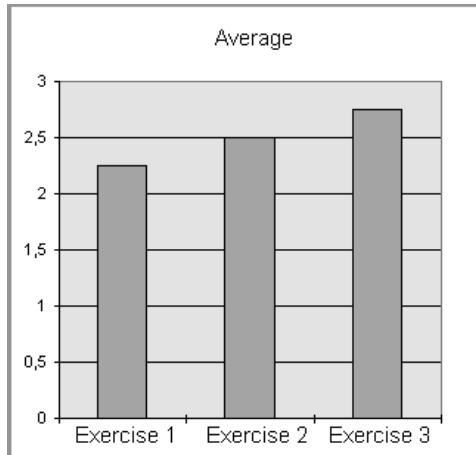

**fig. 44: a column chart**

⇒ In the beginning, working with a spreadsheet is not so simple, especially when charts are used. Practice, curiosity and patience are what are needed for success.

## Mouse drawings

are one of the most advanced uses a computer can be put to. Even the better office programs like Word, Excel, WordPro, Star-Writer and WordPerfect usually have some sort of drawing module. Lines, rectangles, circles in all widths, different shapes and colors, all can be produced, edited, undone, copied and more with a simple mouse click. The illustration shows the drawing toolbar from Word. It is shown using the **View, Toolbars...** menu command. When you click on one of the buttons and move the mouse over the working area, the cursor changes to a cross. To draw the desired object, hold down the left mouse button and drag. Later you can color your object, move it, scale it (computer talk for changing its size), and much more.



## Drawing with vectors

This type of accessory program is called a vector drawing program, or just a drawing program. Here the processor calculates every element individually. A circle is defined by its radius, for instance. Polygons are calculated using their corner points. If you enlarge your picture, all the objects are recalculated at once, and the results are immediately shown in the program. This means that such a process has no effect on quality!

A 'real' vector program is very impressive when it shows off its special functions. The more simple of these include mixing, mirroring, turning, rotating and distortion of a picture.

*Corel Draw* has had – since version 4 – extensive accessory programs which can do things like make animations. Micro-grafx Designer is just as powerful a program. Corel Presentations can also do nearly everything needed. **Price tip:** If you can manage with an older version of Corel Draw you can save a lot of money. The program also includes hundreds of fonts and thousands of what are called

Clipart drawings – small pictures. CorelDraw pictures have a `cdr` extension, Word pictures end with `wmf`.

## Everyone a van Gogh – painting programs

Corel Draw includes a program called Corel Photo Paint. This can be used for manipulating, retouching and generally working on scanned photographs. Other well known painting programs include Adobe PhotoShop and Paint Shop Pro (about \$70 for the latest version at time of writing). The program Paint(brush) is included with Windows.

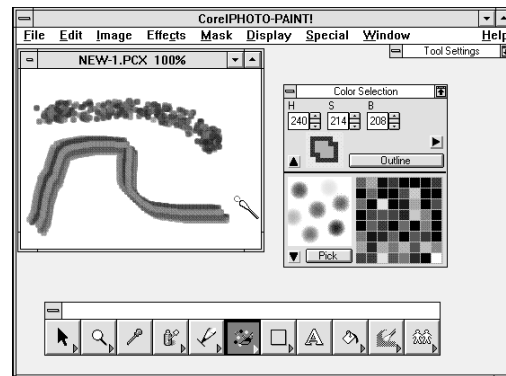

**fig. 45: The impressionists brush**

Painting programs display a picture by using its individual points, called pixels), which gives a considerable loss of quality when a picture is enlarged. The big advantage with painting programs is the artistic effects they have available, like color palettes, spray effects, wide and narrow paintbrushes, etc.



**fig. 46: A photo - scanned and manipulated**

The best known file format for pixel format pictures is `bmp` – for bitmap.

## The data-base as information container

When I recently received a printed advertising letter for dog food through my letterbox my first thought was that someone could not read. It is for a very good reason that I have a notice on my door saying 'no advertisements, please'. But on the way to the rubbish bin I noticed that it was addressed directly to me, and, as if that was not enough, the sender was cheeky enough to suggest that he knew me ('Dear Mr. Hanke..') and was trying to engage me in a discussion on our mutual interest, dogs.

That so many firms can coldly and aggressively bombard little innocent me with their advertisements unfortunately has something to do with electronic data management.

### You have won.

'Dear Mr Smith, Jones, Owen, Wellard', 'Dear Mrs Edgar, McEwan, or Johansen. Just call ...' and so on. If you ever receive (and who hasn't) such a 'personalised letter' you can safely assume that a database is behind it. Your address is stored as data next to hundreds of thousands of other addresses in what is called a relational database.

Such a database is built up as a (huge) table, where every row is a *dataset*, made up of fields like: title, name, forename, number, street, town, postcode, hobbies, work and so on. Relational databases have the great advantage that the tables can have a relationship with each other. One table in the database can contain addresses and customer numbers, another contains customer numbers and orders, etc..

Well known databases include dBase, Paradox, FoxPro, Access and FileMaker. As well as relational databases, there are also, what are called full text databases which are just right for administrating large, unstructured texts like quotations. Databases are not just a PC's speciality, they were found decades ago on mainframe machines.

The following illustration shows a database in Microsoft Works. This program can store an ocean of data sets – but you can also make do with the Microsoft Works database, which can 'only' manage 32,000 data sets!

These are all more than sufficient for home use. Works, for example, will let you move from form to list display.

Hfd.Nr.	Ort	Linien	Vorreinschneide	Nach	Bemerkungen	Bezirk
61	Pastor Niemöller Platz	52,53		1		Pank
62	Bäckerstr./Altegeleiedamm	50,51				Köp
63	Fürstenwalder Str./Muggelseed	61	1		1996 neu programmiert	Köp
64	Alt Mahlsdorf/Hubsch. Damm	62		1		Köp
65	Grünauer Str./Glöwencker Str.	58		1		Köp
66	Preussauer Promenade/Langham	13,23,24		1	6/96 mit Kontakten nach Wei	
67	Langhansstr./Gustav-Adolf-S.	13,23,24		1		
68	Rhinstr./Oärtnerstr.	18,26,26			1 Vorlaufzeit erheblich zu I.Hobs	
69	Greifswalder Str./Thomas-Mann	2,3,4		1	2, abends nur 1 Freigabe/PfBg	
70	Greifswalder Str./Ostsee	2,3,4		1	schlechter als Vorgänger/PfBg	
71	Greifswalder Str./Danziger Str.	2,3,4		1	schlechter als Vorgänger/PfBg	
72	Greifswalder Str./Hufelandstr.	2,3,4		1	Linksabbezugspur nach -PfBg	
73	Mollstr./Köbelstr.	2,3,4,5,6,8,15		1	schlecht programmiert, LMitte	
74	Treskowallee/Erlichstr.	21,26,27,28		1	für abbegende 21 verbaul/Kafah	
75	Schönhauser Allee/Bornholmer	23,24,50,52,53				PfBg
76	Bornholmer S./Schönfläcker S.	23,24,52		1		Pank
77	Bornholmer S./Byernstr.	23,24,52			umgebaut 95	Pank
78	Treskowallee/Wandstr.	26,27,28		1		Kafah
79	Bahnhofstr./Lindenstr.	26,60,61,62,67,68		1		Köp
80	Muggelheimer Str./Wendensch	26,62,67		1		Köp
81	Duschallee/Gutzfelder S.	2,4,13,19,23,24		1		Wei
82	Königs-Wald-Str./Hauptstr.	5,13,15,18				
83	Landsberger Allee/Friedenstr.	5,6,8,15		1	zwischenzeitl. umprogrammiert	Ffhn
84	Berliner Str./Esplanade	50,52,53			schlecht mit vorher u.	Pank
85	Berliner Str./Maximilianstr.	50,52,53			schlecht mit USA-U-BfH	Pank
86	Berliner Str./Kissingerstr.	50,52,53		1		Pank

fig. 47: Data base: View list

### Filtering data

What makes a database so exciting is how it lets you sort and filter data. In database language this is called a 'Query'. So, for example, you could search for all the people who had a dog at home, and then send a letter out to only those people. You can find out much more about databases and their very advanced facilities in booklets about Access.

## Music on your PC

Every PC has a built in loud-speaker, but that is usually only used for audible warning signals. It is not very effective for music or any kind of natural speech. Without a sound card you have no entry into the world of computer noises. If you have a Mac, however, this rule does not apply. Apple PCs are born with the ability to make beautiful noises.

Windows offers two commonly used file formats for sound. There are **Wave** files with the \*.wav extension, normal sound



files which can contain sounds, noises, music or human speech. The autorecorder included with Windows allows you to use your PC like a tape-recorder (see page 51). A microphone can be plugged into most sound cards, and then afterwards you can manipulate your voice and add diverse effects. But wave files have one large disadvantage, they need a huge amount of storage space on your hard disk. 60 seconds speech can, depending on quality, take up as much as 1 MB on your hard disk. Incidentally, wave files are so called because it is the actual sound waves which are recorded.

### It is the card which makes the noise

The quality of the sound card plays no great role in the playing of a Wave file. Here – when we are talking about playing an Audio-CD – a reasonable enough stereo sound card can be had for under \$70. But when we are talking about the other file format, it stands and falls with the quality of the hardware used to generate the sound. This file format is called a → **Midi** file. The **Midi** standard (**M**usic **I**nstruments **D**igital **I**nterface - a digital connection for musical instruments) does not save the sound file in the normal way – it saves information solely as instructions as to how the sound should be generated.

If it is a piece of piano music, for instance, then the sound card is just given generating instructions. An example: create the piano tone C for a period of (1/8 second), followed by A, G and H, each for 1/4 second. In parallel with this, the hardware component is also given instructions for other voices and instruments, but the results of these codes is solely dependant on the quality of the sound card.

A simple card tries to generate a piano sound. What comes out is more a reminder of a synthesiser from the seventies. Synthesiser – all that means is that sound is generated synthetically. If you want any kind of realistic sound, then something dearer is needed. A → **wavetable** card, which contains each individual instrument sound in a chip. The

sound in a computer game is much better if you have a good sound card. Top models can cost up to a thousand dollars. These contain up to 128 separately defined instruments with selected sound patterns, called samples, and it is nearly impossible to differentiate between real and 'sampled' instruments. Such cards are produced by companies such as Roland, Yamaha and Korg.

### Composing without notes

And, of course, there is also software for composing music. Using a → **sequencer** complete compositions can be produced. With these music 'word processors' composers have found something nearly ideal. They can alter, delete or move entire passages in their work almost without problem.

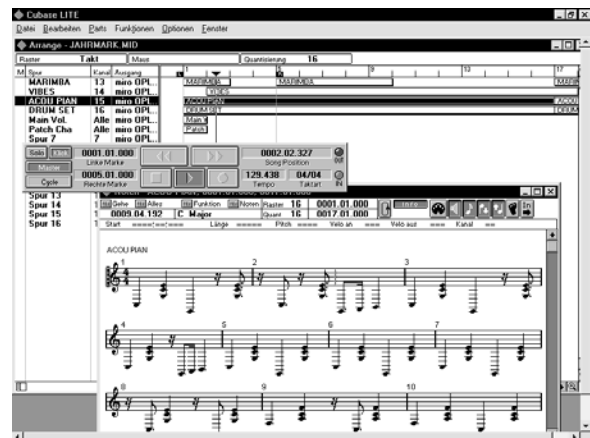
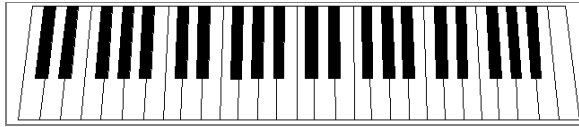

fig. 48: Sequencer – 'word processing' for music

If you have a Midi keyboard, you do not even need to write down the notes. Your 'piano' is connected to the sound card via the Midi port. Now each voice can be played in separately and be converted to written notes automatically. If you make a mistake, it can be edited without any problems.

Many sequencers can also import or export Midi files. In this way you can study a Midi file as a written manuscript, and also save your own small masterpieces as small Midi files and even pass them on. But remember, the quality of your masterpiece on a friend's machine depends

very much on the quality of his sound card.



**fig. 49: Midi-Keyboard for a PC**

Most sound cards are packaged with extensive selections of software – often with a sequencer in a light version. There are also programs which allow you to drag prewritten musical ‘stumps’ onto different tracks. If you have the talent you can simply compose your own top ten hit record on your PC – using a sound card, speakers and Drag & Drop!

### Soundblaster

is the name of the card which has set the standard on the PC. If you want trouble-free sound and music generation in games you will not be able to avoid getting hold of an original Soundblaster card. That reduces the risk of silent games to nearly zero. Other producers may claim to be 100% Soundblaster compatible, but this is seldom the case.

When it comes to sound quality, a Soundblaster is not necessarily the best, not even the most expensive model with a wavetable-module. If you want to find the absolute best ‘orchestra’ you will have to go through some computer magazines looking at serious laboratory tests.

### Checkmate – but who?

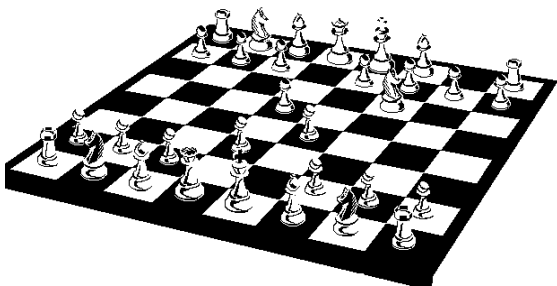

It was a shock when a computer beat chess grandmaster Garry Kasparov for the first time in May, 1997, and not only for

the grandmaster himself! The programmers had prepared the IBM-supercomputer ‘Deep Blue’ far too well for the contest, but not only a supercomputer on public display has such a talent for games, the common PC in home use is also very good, using a chess program like Kasparov’s Gambit, for instance.

And there are exciting, action-packed, Jump’n’Run, air-war, sea-war, flight simulating flying carpets, car races, Memory and Monopoly games – nearly everything can be played on a PC, and demanding graphics, high fidelity stereo sound and realistic 3-D simulations are now the norm. Diverse accessories like sound cards, speakers, joysticks, gamepads, steering wheels and foot pedals give an authentic feeling and guarantee lots of fun.

But it hasn’t always been like this. When you wanted to play on a computer in the 1980s, then a PC was the last choice. Better was one of the popular C 64 home computers. If you had rich parents then an Amiga was part of the standard equipment in the child’s bedroom. These ‘game computers’ were miles ahead of a PC in the area of graphics and sound.

But the Amiga and the C 64 have been gathering dust in the attic for a long time now. The PC has become the first choice, even for games. Let us take a closer look at what sort of games are to be found for the PC.

Windows comes with several amusing games as accessories, like Solitaire and a minefield game. The Windows 95/98 CD contains an action filled game called Hover. In this you steer a raft through a 3-D-labyrinth, accompanied by some soul shattering music, collecting small flags and avoiding collisions with other boats.



**fig. 50: Hover, en gigantic 3-D-labyrinth**

### Strategy and adventure

...this is what is promised by diverse adventure and role playing games. You play the hero in the action and have to carry out some tasks within a given set of circumstances. You have to ask other characters for advice, search rooms, do the right thing at the right time, gain experience, collect things and so on and so forth. The aim could be, for instance, to find some pirate treasure, which can only be done after getting through a number of difficult situations. In another game, designed to teach greater environmental awareness, you lose points if you open a window and forget to close it again. Many of these games contain enough riddles to keep the player busy for several weeks.

### Shoot'em ups

Unfortunately this type of game is very popular among many young boys. There are 'harmless' variants where you shoot down enemy spaceships or aim at fast moving objects, but some would argue that they are not so harmless when the targets are realistically presented human beings. Some games hold nothing back in their action, when the opponent may be sawn to pieces with a chain saw, with blood squirting in all directions. When some of these games also contain subtle racist overtones I do not understand their appeal. Forbidding them would not help,

an intact family and a good social network is more important.

### Dexterity and reactions

This category includes the all time classic computer game Tetris. This Russian best seller exists in many different versions on the PC. Quite simply it is great fun to build up towers and practice your ability to find holes. Tetris is a very successful and interesting game, which trains spatial abilities. Other well know games which train dexterity are Pacman, a kind of 'stone eating monster' and Snakes, where snakes try to eat objects without eating themselves or each other.

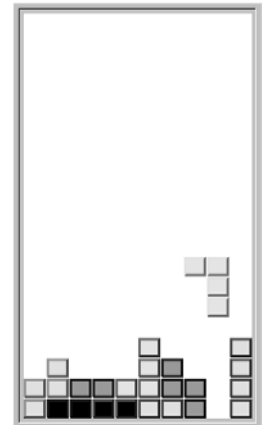

**fig. 51: Tetris**

### Jump'n'Run

This category covers a multitude of different games. Here the hero jumps and runs (as the name suggests) for his life. You are a little cartoon figure with several lives who fights dangerous objects, solves tasks, collects points, works through different levels etc. etc. The figure is controlled with the keyboard or a joystick – and this needs cunning and good reactions. The attractive sound and graphics in these games can nearly turn you into a game addict, I have to admit that it has not been unknown for me to sit for many hours in front of the screen ...

### Simulation games

These are very exciting, akin to adventure and role playing games. Flight simulators let you learn to fly a plane, in a more or less realistic cockpit and under 'nearly real' flying conditions. Other games let you play boss of a large company, or maybe an entire country. One of the most popular and most successful of these types is SimCity from Maxis. More than five million examples have been sold

world-wide, and at least three times that number have been copied illegally.

In SimCity you are the mayor and city planner simultaneously and have to look after your citizens' welfare. Just like real people your 'Sims' build houses, churches, apartment blocks, shops and factories. They need a traffic systems and public utilities, they pay tax, need to take holidays and can only survive if the area does not become over polluted. Catastrophes occur, they complain about bad life quality and so on. Every mistaken decision on your side can have catastrophic consequences for your town's welfare. So you learn to make realistic plans and recognise the linkage between things.

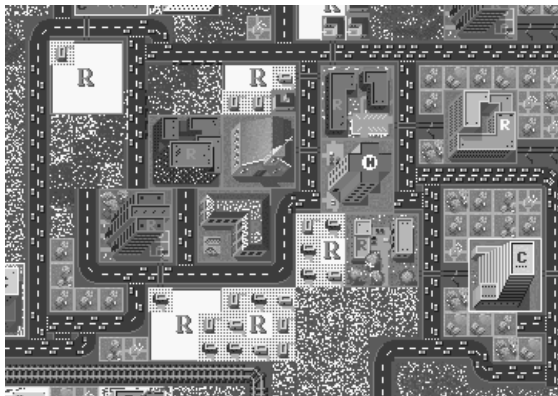

**fig. 52: SimCity – excerpt**

The best part of the game? It can start in real towns like Hamburg, San Francisco or Tokyo. But a game scenario like *Rio de Janeiro 2047, floods* is not such a fantasy when you consider the climate catastrophe we are heading towards if we do not alter the way we are treating this planet.

### How much hardware do you need?

For games? That depends totally on the game. Older games especially, are very frugal. An old 286 with 1 MB RAM can keep you happy. Most games, SimCity 2000 included, need at least a 486 computer with 16 MB RAM. More demanding games with high video resolution, video clips and action can never get enough resources. A fast Pentium computer with a good graphic card is the least you can get away with. A sound card is a must for most games, and its quality (and also the

speaker quality) has a great influence on the sound quality. You can do without a joystick, most games can be successfully controlled with the keyboard alone. As far as operating systems go, DOS is fine for most games, even the newest. However, most can be played without problems in Windows 95/98 – Windows 95/98 contains a complete DOS.

### To steal or not to steal...

... the best thing to do is to look at what is available as shareware. Large stores and computer supermarkets often offer cheap CD-ROMs, which contain hundreds of shareware games. The big advantage is that you can try them out in peace and quiet. Commercial games are not cheap. It will pay you to try them out before buying them, maybe a friend has a copy? You will certainly find some games on the cover CDs of computer magazines. There are magazines which specialize completely in computer games, like PC Player. These contain playing tips, information, reviews of many different games. And you can buy older or less successful games on special offer. Even the most successful games are often re-released after some years. For example, at the time of writing SimCity can be found very cheaply in a Multimedia edition, including playing instructions!

Many 'serious' people see computer games as nothing more than a bad habit. They look down on these poor people who waste their computer time with such worthless things, and maintain that they are just another pacifying drug. 'You would never find me touching a computer game', they say, but when they first get bitten even the most hard bitten of them find they can like a game or two. Solitaire, which comes with Windows, is an excellent way to train your use of the mouse, for instance!

Games are exciting and fun, providing you do not use all your time on them. Incidentally, if you play many games you ought to familiarize yourself with DOS commands. (see page 22).

## Multimedia and other fashions

What does multimedia mean? A computer expert has coined the definition:

'Multimedia is everything with more than 7 wires attached'. Let us just take a peek behind the computer, yes, even I have a Multimedia machine!

There is actually no real definition of multimedia. But let us use some examples to illustrate what it is.

### Moving images and music

Multimedia – pictures, sound and video in an interactive combination. Full stop. When you click somewhere and a small film plays, then it is interactive and multimedia. In this case it is the film media which is used. If you run the Jungle sound effects in Windows 95/98 then snakes hiss every time you start a program and those on the Task Bar are all looked after by animals which I would rather not run into. This is a clever way to use sound, and Windows 95/98 really shows off its multimedia abilities with such an accessory.



fig. 53: Multimedia-film in Windows

To activate different sound schemes in Windows 95/98: click on **Start**, point at **Settings – Control panel** and then double click on **Sound**. The dialog box displays a list of different sound schemes, if you have installed them when you installed Windows 95/98. Choose the scheme you

want by clicking on it. Of course, you will need to have a sound card and speakers.

### Guaranteed fun

There are multimedia teaching programs, where a virtual professor explains something to you. If you have understood the lesson, then you can show off your knowledge at the end of the program, and if you put your tick in the right place, then applause streams from your loudspeakers.

And for language teaching programs a combination of text, film and sound is a brilliant aid. Ordinary everyday situations can be shown on screen, the right pronunciation demonstrated and the motivation to join in is high.

The rhythm of teaching is totally dependent on your own tempo. A well thought out multimedia program is a real enrichment of the software market.

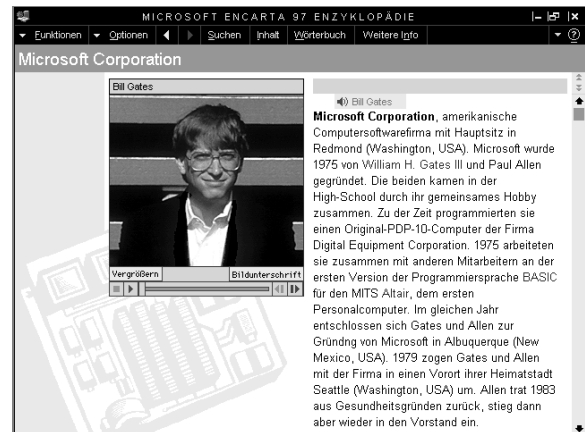

fig. 54: multimedia encyclopaedia with 'Bill'

There are CD-ROM encyclopaedias which can do much more than any printed book. Besides being able to search by keyword, which only takes a second, these programs also contain all sorts of extra functions: sound and video clips of various occasions, illustrated animations, cross references to other articles which can be activated by a mouse click and so on. But be careful, not every expensive multimedia CD is worth the money!

This is precisely the market where some publishers try to take peoples' money with cheaply produced old clichés. Ask your

friends for recommendations before opening your wallet. You may find some bookshops which will let you look at some of these programs on the shop PC. If you have the chance you should certainly take it, after all, you are usually able to leaf through a book before buying it.

### Multimedia PCs

are actually just normal, though fast, PCs. They contain:

- CD-ROM drive
- sound card with speakers
- Windows 3.1/3.11, or, even better Windows 95/98
- probably a microphone

Windows allows sound and video to be played.



**fig. 55: a modern Multimedia PC**

A word about usual PC videos. These are usually shown in a rather small window. When this is enlarged you can see how terrible the picture quality actually is. The resolution of the PC's living pictures cannot be compared to the ordinary home video. Better quality comes from what are called MPEG-video, but these require special MPEG ready graphic cards or MPEG software, which is only available with the latest versions of Windows 95/98.

Let us see what Windows 95/98 can actually offer. Click on **Start**, point at **Programs – Accessories – Multimedia**. Here you will find an **Audio-sampler** for recording and manipulating your voice, a **CD player** for ordinary Audio-CDs, a **Sound**

**recorder** and a **Media player** for sound files and video files.

Maybe you would like to try your hand at producing your own Multimedia program. With what is known as an 'authoring' program it is very easy to start. You do not need to program every line. An inexpensive alternative is **Medi8or** which is included on various shareware CDs. This allows you to painlessly produce electronic greetings and postcards, dictionaries and encyclopaedias, Multimedia catalogues, brochures, handbooks and interactive educational programs. And it goes without saying that they will be full of animations, sound, videos and so.

## Everybody's talking about it – the Internet

It is all the fault of the American military. At the end of the sixties they fiddled around with a data-net which would be able to survive a nuclear war. In other words, even though most of the connections may have been destroyed, any messages would still be able to get through to their destination. So they developed a method of transferring data by dividing it into small packets.

So your e-mail is cut up into little bits, each of which gets to its destination by taking a different route. One pack wanders using satellite or special cables via Hamburg, America and Spain, while another goes three times around the globe before arriving intact at your friend Sanchez in Madrid, and it all depends on which lines are free. This subtle transfer method is called TCP/IP.

The Internet is a huge, world girdling, decentralised spiders web, much more flexible, faster and cheaper than the telephone system.

### A word wide spiders web

If you want to start on the Internet, you will need a modem. A V.90(56 kbit/s) → **modem** will cost about \$100. If you have a digital telephone line you might need an ISDN card/adaptor. Do you already have ADSL (**A**synchronous **D**igital **S**ubscriber **L**ine)? Lucky you are! This new technique is as quick as lightning, it allows download rates up to 8 Mbit/s!!! In this case you need a special ADSL-modem.

ISDN-card, modem, ADSL-modem – this apparatus links you to your **Internet service provider (ISP)**. This is a company who (for a payment, of course) link you via your telephone to the Internet. You pay a subscription every month (and possibly a once only connection charge), plus – not to forget – ordinary telephone charges to your telephone company.

You can also connect to the Internet via what is called 'on-line services' like AOL. These usually let you test the service by installing the necessary software from a

CD-ROM! The popular computer magazines usually come with a free cover CD, where you can regularly find these programs. And you may well find a free trial connection to an ISP included in the box when you buy a modem.

### E-Mail – express post!

When you have got through the setting up process you will receive an e-mail address and an electronic mailbox. If you want to receive mail, you must ring to your ISP and use your mail program to check it. If you have got a letter, you can read it, print it out or save it. Electronic mail is more practical, much faster and more simple than ordinary post. A letter only costs the telephone costs for the time you are on the line to send it (just a few seconds) even if it is to the other side of the world. So make sure you have an ISP that you only need pay local call tax to.

Incidentally, ordinary mail is called 'snail mail' by Internet enthusiasts.

### Surfing along the three big W's

What is called the World Wide Web, or the WWW, W3, or even World Wide Wait (when it goes slowly) is a relatively new part of the Internet, though it is by far the most popular. It was started in 1989 by some atomic physicists who wanted to share their results from all corners of the world a bit faster.

Since then the WWW has gone through a furiously paced development. Today it is possible to see millions of documents, and each day brings even more. These are the famous web pages, containing music, video and animations to name but some effects. Many firms and special interest groups today have something to offer on the Internet.

What is special about these pages are their cross references, called **Links**. For example, Garry Kasparov's web page contains a link to the IBM company. Clicking on this jumps you immediately

from Kasparov's web page to a page detailing the IBM computer 'Deep Blue' – even though this page is somewhere else in the world entirely.

These links are usually displayed as highlighted colored text, called Hypertext, but graphics are also often used. It is as though you could click in the card index in your local library and the book you wanted appeared in your hand immediately.

To view the pages you need a **browser**. Browser – from *to browse* – a program which lets you browse the Internet. You will often be given a browser by your service provider.

At the moment the most important browsers are Microsoft's *Internet Explorer*, and Netscape's *Netscape Navigator/Communicator*. Both programs have a current version of 5.0. New versions can often be found on computer magazine cover CDs, and always on the Internet.

The best browser is *Opera*, small and beautiful. It is incredibly fast, even on slow computers. The catch – Opera is not free of charge. But you can download an evaluation copy from [www.operasoft.com](http://www.operasoft.com).

A web page has a web address, which is why it can be viewed from anywhere in the world. If you want to go to a particular page you type the address in the browser's address field.

[www.KnowWareGlobal.com](http://www.KnowWareGlobal.com)

Press **Enter** and after a short downloading time, the page will be displayed in your browser.

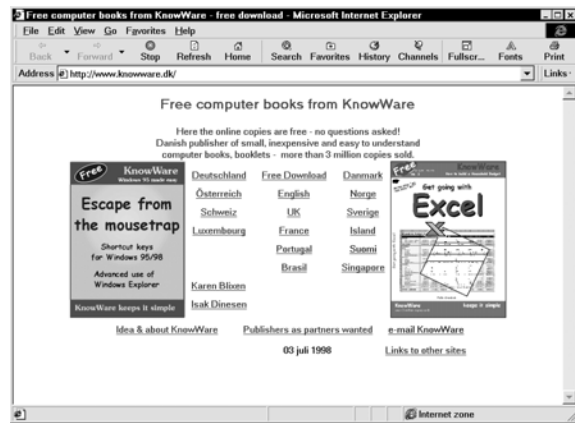

**fig. 56: A web page as it appears in a browser**

If you are looking for addresses, you will be helped by what are called **search engines**. These are supercomputers containing gigantic databases, like [www.altavista.com](http://www.altavista.com) and [www.yahoo.com](http://www.yahoo.com)

You type a search word in the form, and when you press the **search** button the super-machine looks for an answer. Then it generates a list of all the pages which have something to do with the subject you are looking for. When you click on one of these addresses you are immediately transported to the page in question. This way of jumping around on the WWW is called 'surfing'.

## Home, sweet home – my own homepage

Most service providers today let you place your own home pages on the Internet. The size of your web page or 'home page' (as it is sometimes known) depends on how much space you are allowed. The German author Susanne Fischer makes this ironic comment about self publishing on the web:

'If you are really unlucky you will land on the Hansen family (just around the corner), or the Smith family (in Chicago, just around the corner). And in peace and at leisure you can stare at Carl and Amalie Hansen's wedding photographs or read just how many dead mice Felix the cat brought home last week.'*(freely quoted from Spiegel magazine special 3/97)*

But do not lose hope, press on and play with your own homepage! After all you are paying your provider enough money, you might as well have full value. You are sure to be able to find something special to make your home page attractive. You could open a museum with pictures and sound, publish interesting news about important things, tell the world about the town you live in...

The more interesting your home page is, the more likely it is that surfers will return there. Advanced web page authors can even install a counter.

And by the way. Even though it might be called a home page or a web page, in reality it is actually several pages. To be strictly accurate a home page is actually the first page of a Web site (an entire web publication), and corresponds to the cover of a magazine or the contents page of a book. The rest of the pages are reached using internal links or cross-references.

If you want to learn more about the Internet, then you had better read

⇒ ***Get going with the Internet***

These booklets will also tell you all you need to know about Newsgroups, Internet chat, e-mail, finding and downloading program files and so on.

## ... me too, I want a PC!

One of the most important moments of your life might well be buying your first PC. Of course, it will be the most modern machine available, with everything, and not cost a fortune! But, wait a minute, you probably do not need everything. Maybe a used computer can do everything you require. My first machine was a second-hand one, and it is today – after many upgrades – my dream machine. Read on, this might well save you from a nightmare when you buy your PC.

### Which computer is my type?

Well, it has nothing to do with the computer companies' advertising campaigns. If you take notice of them the least you can get away with has pipeline, burst, edo, cache, superfast, software plus, big-foot, 500 Mhz, corel draw, Pentium Pro III, games control etc. What on earth is all that? I am sorry, I do not understand all of it, but when you read an advertisement, start by reading the following points, or look up our little mini-dictionary.

- The PC you buy today will be hopelessly out of date in three months. By then you will be able to buy a much more powerful machine for the same price.
- Under all circumstances a **CD-ROM drive** should be included.
- I would not buy a (new) PC without **Windows 98** or higher pre-installed.
- A **used PC** is a gamble. You need to be very good at negotiating a price, and also to have an experienced friend if you are not going to end up disappointed.
- A **brand name** computer is (maybe) a good idea. It will be of better quality, will last longer, and might be slightly faster as the components will have been designed to work together. Economically it might well be that a longer guarantee period with 'free' user support is the deciding factor.
- The final argument is the **software**. The fastest and most expensive computer is valueless if the programs are

full of bugs (errors) and badly written. Unfortunately many programs are (expensive) botch jobs!

Do you still want a PC? So we better see what type *you* are:

#### The economical beginner type

has never worked with a PC and does not know so much about them yet. He wants to try everything and has not yet decided on a particular type or on what he wants to do. He buys a **complete pack**, as suggested by the salesman. This includes color printer, sound card, software etc. Of course, the price must be right, not over \$1,000. OK, so it is nearly impossible to make a mistake. Make sure you get at least 16 MB RAM, and the graphic card should have at least 2 MB RAM.

#### The Multimedia type

also wants to have **fun** with his computer, and it should also be inexpensive! Remember sound card and speakers, or Multimedia is meaningless. If you can afford it, a larger monitor (at least 15 inches, see page 13) is well worth it. Do not buy a slow machine. Less than 64 MB RAM and a quick Pentium (or corresponding processor) cannot really manage it. If you want good sound, you cannot afford to save on either sound card or speakers. For music you will also need a → **Midi Keyboard**.

#### The nerd type

You will have met this type, he is the one who can only talk to his friends about processors, CD-ROM drives, clock frequencies and so on, and constantly scours the local newspaper's advertisements for used **PC parts**. About every three months this rather sweet person adds a new piece of hardware to his PC. And he is lucky, it usually works, at least after the third or fourth attempt. A satisfied smile and deep feeling of fulfilment characterises him after the successful integration of yet another component. Nerds spend most of their income on the newest in computer

technology, but are still unable to follow the latest technical developments. Great enjoyment, very bad value for money. Welcome to the club!!

#### The serious type

uses his PC for his work. He will **not accept rubbish!** He mainly uses his PC for word processing, spreadsheets and graphics. He can do without Multimedia. The serious type will certainly find that a used 486 can do everything he needs. It is only the monitor and printer he really makes demands on. At any rate, he spends much of his time sitting in front of the screen and prints out 'serious' documents. The serious type saves money on the processor and uses it on his printer and monitor. For this workaholic **Microsoft's products** (Word, Excel, Access, PowerPoint) are unfortunately (still) the best.

#### The graphic type

needs more than anything else a large monitor, a color printer and lots and lots of RAM. The conservative graphic type still buys a Mac, because he always has. The graphic type loves working with this PC. He only needs two programs – Adobe PhotoShop and Corel Draw, the latest versions, of course. And he also needs a high quality printer and a → **scanner**.

#### The student type

has very little money, so he has to settle for a cheap, used machine, and why not? He 'borrows' his software from friends, but be careful. Sellers of used machines usually expect much more than they are worth. About \$150 should get everything this type needs, including printer. And as for 'borrowing' software (pirate copying), see page 59.

#### The writer type

uses his PC like an **electronic type-writer**, and so a used machine is fine. If he must have a new machine, then it is best to buy a type which is about to go off the market. And there is no need to buy

the most up-to-date word processing program. Only the printer and monitor need to be of reasonable quality. And there is a sub-group to the writer type, one who spends months checking out computer shops on the track of the perfect keyboard – someone like me. When such a type sets foot in a computer shop, the salesmen run off screaming!

#### The 'only the Internet' type

really needs to ensure that his computer has a fast serial port (**FIFO**) - even a used 486 can be used successfully on the Internet, and if you are practical you can upgrade the FIFO port yourself. Of course, this type needs a fast analog modem (33.6 and faster), but an ISDN card is better, if, of course, he has an ISDN connection. Much better is ADSL. It is important to find the right Internet service provider and the right software. KnowWare has published several booklets on the Internet.

#### The games type

needs just one thing more than anything else – lots of money! This poor person will be using all his resources to keep upgrading his computer. Mainly the graphic card, but also the processor and RAM needs to be modernised continuously. It could be that a video sequence jumps, and the latest all action game is certain to demand more hardware than he has. There is no way around it: **Upgrade!** Next time it needs to be something with → **MMX** – or whatever it has become by the time this booklet is published!

#### The on-the-move type

cannot bear life without his → **notebook!** There is a little less to show off for the money than a desktop machine, and they are hard to upgrade, and due to the price they do not come so well equipped with RAM, hard disk capacity and free software. Make sure you try the machine out before you buy, making sure that the keyboard and mouse substitute are comfortable and check how good the screen is and (especially) how long the batteries last!

**Maybe you are a combination of several types?!**

**My tip:**

Unfortunately I cannot recommend any particular hardware producers here. And I will not say that you should only buy at a discount warehouse or mail order. The little shop around the corner can often give advice which is worth its weight in gold, and if there are problems you can find a friendly assistant, which can mean a lot, especially if you do not know any computer 'experts'. Mail order and computer supermarkets can boast of good prices and attractively bundled software packages. These are no bad thing, and it is nearly impossible to go wrong, especially if Windows 95/98 or higher and Word, Works or Excel are included! These programs usually cost a fortune. Other manufacturers can offer computers individually constructed with components specified by the customer. A supermarket or mail order firm can easily sell the same computer with a hard disk from Seagate or Conner this week, and from Quantum or Maxtor next week. And the graphic card can be this one day, and that another. Only the price does not change.

**My advice**

- get well informed (from computer magazines)
- investigate the quality of the advice the shop is willing to give
- compare prices, do not buy the first thing you see
- save money on the processor – even the current slowest is fast enough
- buy RAM – at least 64 MB, but 128 MB is better
- with a CD-ROM drive pay less attention to speed (6x is more than good enough) and more on error correction.
- buy a good monitor
- choose a good laser printer or ink jet (see the next chapter)
- check what software is included
- get the programs on CD-ROM – pre-installation is not good enough.

Never forget that the Newer-Faster-Better merry-go-round is a deliberate marketing ploy by the industry. Computers can simply never be good enough. An older machine, which could still be used for many things, is simply thrown away after a couple of years, while new programs make even higher demands on hardware. The hardware industry encourage this development with glee and builds even newer, even better PCs, which again lead to the development of even more demanding programs which are (apparently) even easier to use. But a lot can be done with older, well thought out programs! A splinter new, '2000 Office Line Super PC' or similar does not always mean a simpler way to work!

**Which printer is the best?**

Well, for the home user there is no doubt which is the worst! The **dot matrix printer**. Depending on the type between 9 and 24 pins hammer away with great force against an inked ribbon and paper. It is even possible to make carbon copies. For the home user this is a dead technology, the quality is simply too bad.

Companies and government departments still use them, they are economical and reliable and can, as stated, be used for carbon copies. You might end up with a

dot matrix printer together with a used PC. But I would never give more than about \$50 for such a printer.

The **Ink jet printer** has a great future, and comes from a great past. Cheap to buy, quiet, compact and reliable are just some of its advantages. It works by squirting small ink drops against the paper, generating clear letters. To achieve photoquality for illustrations special paper is needed. There are some disadvantages with ink-jets. The ink will run if it gets wet and they are expensive to use.

If you print in multicolors, steer clear of cheap models, you will need an ink cartridge with separate containers for the three basic colors and black. If not, you will have to throw away the entire cartridge as soon as just one color is used up. It would be fine if there were cheap refills for ink jet printers, but the new, highly tuned ink-jets cannot be refilled without problems. A simple (new) ink jet will cost about \$170.

**Laser printers** win with their excellent quality. They work by fusing finely powdered toner dust onto the paper with the help of a laser. The toner is then fixed by heat. A laser printer is usually very fast and prints out whole pages at a time. They contain complete little computers with their own processors, RAM etc. Despite their reputation they are actually cheap to use – I speak from experience. A simple laser printer costs from \$300 and up. *Color* laser printers are still far too expensive for home use for most of us.

**fig. 57: A fast laser printer for office use**

And remember what I said about driver software, this also applies to printers. The print quality is

not only dependant on the model, nor on the, often optimistic, resolution specified on the packaging. It all really depends on a good driver. My HP laser printer miraculously improved its print quality as

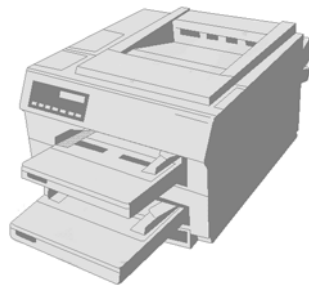

soon as I installed a new driver. So it can really pay you to regularly check CDs for new drivers, or search for them on the Internet.

If you do a lot of printing it is wise to ensure that the printer is of a high mechanical quality. Some of the cheaper models are so rickety that paper jams are part of the everyday routine. If you work as a layout artist or similar, you will really need a → **Postscript** printer.

## Lots of lovely programs!

The best PC in the world is not more than an expensive door stop if you have no programs to run on it!

### What you get for your money – A licence to work

Software is expensive. And not only that, you have not actually bought it, and you can never own it. All you buy is the right to use a program – a license. Professional programs like Adobe PhotoShop, Macromedia Director or the Microsoft Office pack can cost several hundred dollars, and you can only take advantage of cheap upgrades after you have bought the full version and registered it.

I do register my software (and end up with a letter box full of unwanted advertisements) but I think the practice is ridiculous, imagine that you had to send a registration card to me when you bought this book.

### OEM or 'how to get cheap software'

OEM stands for **O**riginal **E**quipment **M**anufacturer and is another way of distributing computer software (and hardware). When you buy a new PC the software which comes with it is usually an OEM version. The PC producer buys thousands of copies of Word from Microsoft and installs the program on his computers, taking a small premium for doing so. The price difference between an OEM version and the 'real' version is enormous, which may not seem fair and cannot really be justified on the grounds that an OEM version can only really be sold together in a 'bundle' with hardware.

### Nearly free – pirate software

\$300 for a used PC, and then the same again for a full version of Word? There are not so many who can be bothered with that. Pirate copies are so widespread as to nearly pass without comment, but in fact it is a criminal offence to copy copyrighted software. Of course, there are not many producers who would try prosecuting a poor student, but currently in Europe a very aggressive campaign is being waged

against companies, institutions and government departments. They are being sent leaflets with the question: 'Do you want to avoid this?' on the cover. The picture shows a jail. The campaign is supported by Microsoft and the other big developers and at its heart is the idea that even though they may have bought their software fully legally, they are still potential pirate copiers.

### Shareware – test before you buy

Another distribution method is the shareware concept – software, which can be tested for free before buying. It can be found (nearly) free on a CD-ROM included with a PC magazine or bought cheaply, or on the Internet. Everything from graphic programs, word processors and spreadsheets to multimedia. Many of these programs cannot justify their cost, but some of them are just as good (and occasionally better) than their 'professional' competitors. Shareware can be tested for a period, after which you should register it with the author for a small payment. Do not forget to register and pay if you like the program. They have taken a lot of work to produce. Payment usually entitles you to a manual and technical support if there are problems.

### Freeware and Public Domain

is free software – yes, there is some out there! For example a home user may use the anti-virus program F-Prot free. And I have also found (on a CD) a freeware program, which is much better at its job than Windows Notepad.

### Good and cheap

When you buy your software it is well worth keeping your eyes open for bargains. Excellent professional software which once cost hundreds of dollars can be found for nearly nothing, just because it is a few years old.

### Brand names?

Does it *have* to be Word or Excel? If you use them professionally, then yes. But otherwise? Probably not. Other programs

are often better – and cheaper. For instance the German StarWriter 5.0 is miles ahead of Word when it comes to integration with the Internet! Even some shareware programs include functions which are sadly missing in their commercial brothers and sisters. It is not the name on the package which matters, but what you do with the program. There is one sad thing: there is lots of literature about Windows, Word and Excel, but nearly nothing about other programs.

### Be careful – all is not what it seems!

When we are talking software, these types are found: alpha versions, beta versions and the finished product. Alpha versions are full of errors and are only half (or less) finished. Beta versions can run, more or less, and are a nearly finished software product which is distributed to interested users who can test them. In most instances there are still quite a number of errors to correct, the infamous 'bugs'. It is only when the program can really run that the final version is sent to the shops. Or at least, that is how it works in theory. Today it is an open secret that most software is delivered in a 'final beta' version. The buyers, flooded out with advertisements and marketing have become the industry's testers. No harm is done if all that happens is a command which does not really work, but often the result is a → **System crash**. Under Windows 95/98 the notorious shut down message pops up.

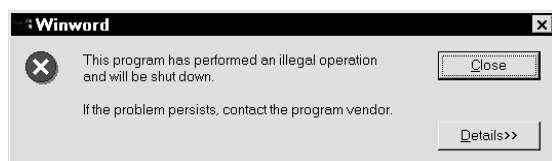

**fig. 58: Here it is again - Windows 95/98!**

Sometimes it is just the current program which closes down, but often it manages to crash all the rest of Windows at the same time – so which developer was it who skimped his work.

I produced the shut down message above on purpose by using an embarrassing fault

in Word 95.

If you activate help by pressing the **F1** key, without a document open, then Word says farewell, and takes a large amount of memory with it. Often a crash can be even more radical, the screen freezes up and the PC 'hangs' and nothing can be done. If this happens the first thing to try is a 'warm reboot' → **warm reboot**. Press **Ctrl + Alt + Del** and hold the keys down. If you are lucky Windows 95/98 will display a list of all running programs and will let you shut down the one which has stopped responding:

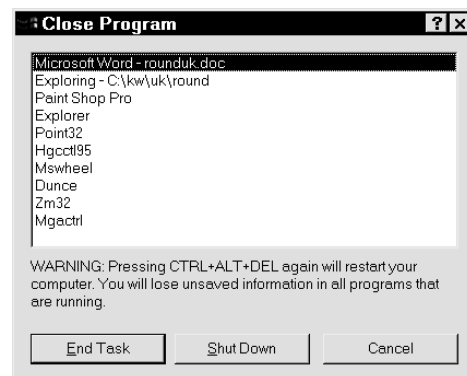

**fig. 59: Ctrl+Alt+Del – first try**

If this does not work, then you will have to try again. If the machine does not respond to the keyboard, then a warm boot activated by pressing the machine's → **Reset** button will usually work. If this does not have the desired result, then there is nothing else you can do except start again with a → **cold boot**. Switch the computer off, wait ten seconds and then switch it on again.

Hopefully after reading this chapter you have understood that it is not always the wisest choice to rush out and buy the newest version of a program. Better to wait a few months until the worst bugs have been corrected. And the same is true for hardware. The newest super 3D high technology graphic card with amazing game acceleration will often prove to be an unfinished test product. So it will often pay to choose older, but well tried and tested (and cheaper) components. The best is if you can find a shop you can trust, with fair prices, friendly service and competent help.

## My PC is ill

The PC is actually a very reliable machine which seldom catches a virus, but if you should end up with one, what exactly is it?

### What is a Virus?

A virus is no more than a very refined sabotage program. Its aim is to spread fast and carry out some specific tasks. The more harmless types of virus do irritating things like play music, distort your screen picture or similar, at a certain time or on a certain date. A nastier type can prevent your computer starting, or delete your entire hard disk. A virus can hibernate totally unnoticed on your computer for weeks or months, and then suddenly activate. If you do not do something about it (even though you might not know anything about it) you can spread it via diskettes or over a network, giving lots of others a nice little 'gift'. The most widespread viruses write themselves into the disk's boot-sector. In ordinary language this means that the virus takes over control when the PC starts – and may even stop the process from being carried out.

This means you must be prepared! Create a start diskette. This, hopefully virus free, diskette will let you start the PC, even though the hard disk's boot sector may be infected. You push the diskette into the infected PC and switch it on, and (with luck) it starts. This is how you make a boot diskette in Windows 95/98:

Click on **Start**, point at **Settings**. Then click on **Control panel**. Then double-click on **Add/Remove Programs** and choose the **Start-up disk** tab. Then just follow the instructions.

Take care if you get disks from strangers (and friends!). They can contain unwanted 'presents'. An anti-virus program can be worth its weight in gold. I use several and regularly check all my programs. Among them are some which regularly send out updates. Maybe you do not need to be so careful, especially as such programs are often expensive, but do take some sort of precautions.

### PC workshops – expensive and not so good

Hopefully your PC will never break down. If it does, then you will have to save up some money, put on a very thick skin and read all the small print about your consumer rights. Joking aside, let us take a look at our patient, the sick PC.

**Case 1:** You decide against a workshop, instead you ring to a PC doctor who advertises in your local paper. This friendly chap visits you for several hours and enthusiastically rummages around in your machine. After a while he mentions that he charges per hour what you earn in a day, and that anyway he cannot do anything, your machine has died!

**Case 2:** You have a workshop you can trust, perhaps the place you bought the machine. Poor you! A large German computer magazine recently tested a number of computer workshops – anonymously and using machines with controlled faults. Only minor things were 'sabotaged'. In most cases the fault was not found, or the machine was still in the workshop, unrepaired, after several weeks. And some (apparently) had parts replaced and charged for when there was nothing wrong with them. And the situation is no better in other countries.

Dr. Jürgen Hogeforster, director of Hamburg's Chamber of Trade admits that: 'There is a clear trend that service is getting worse and worse. And there are any number of cowboy operators. They appear like flies' (quoted from ComputerBild – German computer magazine – 8/97, page 14)

Unfortunately I can only confirm this view. So I have trained myself to be a 'home builder', with success as my fully functional machines show! And I have also found a firm I trust – high quality goods, friendly service, not expensive and with a full return policy.

If you are interested in upgrading and repair, then KnowWare may have published:

⇒ **Upgrade your PC**

## A little about ergonomics

Unpack, setup and run – that is how it should be with a PC. The software is installed, the programs run, what are we waiting for. But wait a minute. If you want to do your body and your health a favor then you should think a little about what your working environment looks like.

### Are you sitting comfortably?

First let us look at where you place your PC's components. The monitor should stand so that you are not blinded by any light. So you should not sit looking out of the window, but side on or with your back to the light.

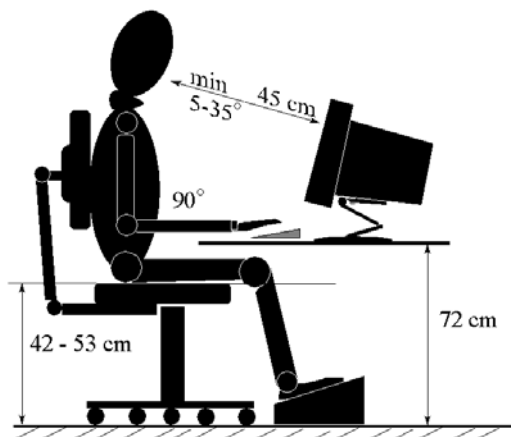

fig. 60: A good working position

A good sitting position is just as important. Use a comfortable, not too soft seat and make sure you have plenty of room for your legs. Your working place should not be too cramped. The best PC in the world cannot be very effective if you have to stretch over masses of things to move the mouse, just because there is not enough room on your desk. This is a false saving. If you work a lot, then reward yourself with a *good*, not too small (at least 15 inch) monitor and a comfortable keyboard. A wrist support lying in front of the keyboard is not a bad idea. Don't get carried away, and remember to do some stretching exercises regularly. And don't forget that it is lovely outside and that you have a lot of friends (real ones, not virtual ones) who are waiting for your visit.

Our example is taken from the German standard for an ergonomically correct work place. I do not have a real office chair myself, but the idea and measurements are useful to know.

### What resolution?

Before you resolve that you really must start with your computer, we will just look at your monitor's resolution (see also page 13) Standard resolution is 640 x 480 pixels, 16 colors are a minimum. This resolution is also called → **VGA** . For basic word processing 16 colors is actually enough, but modern graphic cards and better monitors allow for much more. Picture manipulation needs a minimum of 256 colors. High Color allows for the display of 65,536 colors and True Color can show more than 16 million colors simultaneously. The more colors, the more realistic the picture. Using a Super VGA card resolutions such as 800x600, 1,024x768 and 1,280x1,024 pixels can be used! The table here gives an idea of the different resolutions.



	Standard using <b>640x480</b> points, ideal for a 14 inch screen
	<b>800x600</b> points, recommended for 15 inch and up screen
	<b>1,024x768</b> , for professionals with hardware to match, minimum 17inch screen

fig. 61: different resolutions

In Windows 95/98 the screen resolution is changed in the following manner. Click on **Start**, point at **Settings**, click on **Control panel**, double-click **Display**, choose the **Settings** tab!

## 'Nerd speak' – a little PC encyclopaedia

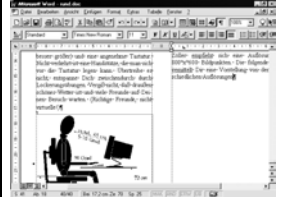
**AGP** Accelerated Graphics Port – new high speed bus from Intel, developed for graphic adapters

**ASCII** 8 bit standard character set, does not support formatting like bold, left margin etc. Supported by all word processing programs

**backslash** reversed slash, used to separate directories and files as in: C:\GAMES\SIMCITY.EXE

**binary system** number system which only recognises two states, 1 and 0

**BIOS** chip, that controls, among other things, the computer's start sequence. This is where information about different drives and so on is held.

**bit** smallest amount of information a computer can handle. A character consists of 8 bits

**boot** starting a computer

**browser** A program which can display documents on the World Wide Web, such as Netscape Navigator

**byte** equals 8 bit (see page 19)

**cache** an extra area of RAM which is used to speed up a PC by holding the last used information.

**clock frequency** number of impulses per second. The higher the better

**cold boot** The PC is switched off completely, and then switched on again. Sometimes necessary after a crash.

**COM port** serial port in a PC for connecting the mouse, modem, etc.

**CPU** processor (the computer's central part)

**decimal system** the usual number system 1, 2, 3

**DOS prompt** the place you type in DOS commands, usually appears as: C:\>

**DOS** well known operating system

**Drag & Drop** important mouse technique used for moving objects

**driver** mini-program for controlling hardware, (sound card, printer, etc.)

**DTP** layout and publishing on your PC

**EDO-RAM** very fast RAM

**EIDE** (Enhanced IDE), a developed IDE standard

**e-mail** electronic post which can be sent over internal networks and the Internet

**FIFO** a fast port specification (UART 16550), important for Internet connections

**hard disk** the computer's built in storage medium

**hardware** concrete parts of the computer (monitor, keyboard etc.)

**HD** High Density diskette (1.44 MB)

**homepage** (electronic) publication on the World Wide Web

**HTML** code language for WWW pages

**HTTP** transmission protocol for WWW pages

**IDE** port for connecting the hard disk and other drives

**Internet** world-wide computer network

**ISA-bus** original data transmission system for the IBM PC. Still used together beside the more modern PCI Bus.

**Kilobyte** equal to 1,024 Bytes (see page 19)

**laptop** reasonably sized portable 'mini-PC' which can sit on your lap.

**Login** attaching to a network or password protected area on a PC.

**LPT port** parallel port in a PC, used for a printer, for example.

**Megabyte** equals 1,024 KB (see page 19)

**Midi-Keyboards** keyboard attached to a sound card used to mimic musical instruments (helped by a special sequencer).

**Midi-standard** (General-Midi) commands for generating the sounds of 128 instruments and percussion using a sound card

**MMX** (Multi Media eXtension) extra commands for the processor, accelerating graphic generation. (3-D, Video)

**modem** accessory to enable data to be transmitted over telephone lines, used for e-mail, fax, Internet etc.

**motherboard** The most important part of a PC

**mouse** input device on a PC

**multimedia** playing of sounds, videos, interactive programs etc., all new computers are multimedia

**multitasking** the ability built into some operating systems to process several things simultaneously

**notebook** small, portable 'mini-PC', smaller than a laptop

**operating system** Basic program in every PC. The most famous one is DOS

**parallel port** fast port for transferring data over several wires simultaneously

**PCI-bus** fast data transmission system for the PC. The latest system

**Pentium** fast processor type from the Intel company

**pipeline** allows fast access to the electronic components.

**pixel** a single point in a picture

**Postscript** printing standard from the Adobe company, used for professional output

**processor** calculating chip, the heart of the computer

**Provider** a firm offering connection to the Internet and e-mail

**PS/2** connection standard developed by IBM (PS/2 mouse, PS/2 RAM block)

**RAM** the computer's working memory

**reset button** button for warm booting a PC

**ROM** Read only memory, cannot be written to

**scanner** input device, reads a document in a fax or photocopy machine, and converts it to pixels

**screen frequency** tells how many times a second the picture is built up on the screen. Values under 71 Hz appear to flicker

**scroll** move the contents of a window

**SCSI** very fast port for adding accessories to a computer (hard disk, scanner etc.)

**sequencer** 'word processing' for notes

**serial port** slow port, transfers data in a series one part after another

**SIMM** older type of RAM chips, require special SIMM connections on the motherboard

**software** programs for the computer

**SVGA** Super VGA, allows higher resolution than VGA, at least 800 x 600

**system crash** the machine stops responding to commands

**TCP/IP** transmission method (protocol) for sending data in a network

**USB** Universal Serial Bus – new bus system that comes with Windows 98, a USB-scanner crashed the system when Bill Gates presented his new Windows 98 to the public

**user** 'used by a computer expert when he means to say idiot' (Dave Barry, quoted from Der Spiegel). A term I do not use myself, jch

**VGA** standard screen resolution 640 x 480 Pixels

**virus** sabotage program designed to replicate itself and cause problems

**VLB-bus** fast data transmission system for the IBM PC, now replaced by the PCI Bus

**warm boot** restarting a computer after a crash by using the reset button or Ctrl+Alt+Del

**wavetable** the part of a midi card which saves the sound picture of natural instruments

**Windows** well known graphical interface

**World Wide Web** graphic and multimedia part of the Internet.

„Windows, 26; 29; 34;  
47; 49; 50; 57; 60  
286, 27; 49  
32 bit software, 35  
32-bit-software, 21  
386, 21; 27; 35; 49  
486, 56  
ADSL, 52  
AGP, 22; 63  
alpha version, 60  
Altair 8800, 9; 12  
AOL, 52  
Apple, 9; 10; 34  
Apple Macintosh, 10; 12;  
29; 34; 45; 56  
arrow keys, 39  
Audio-CD, 46; 51  
Audiosampler, 51  
Babbage, Charles, 6  
backslash, 24  
backup copies, 30  
beta version, 60  
binary system, 6  
BIOS, 22  
bit, 6; 21  
bitmap, 30; 44  
boot diskette, 61  
boot sector, 61  
browser, 53  
bugs, 60  
bus, 21  
C 64, 14; 47  
C drive, 31  
cabinet, 13; 16  
CD-ROM, 13; 15; 21;  
49; 51; 55  
cell address, 41  
cells, 41  
charts, 43  
Clipart, 44  
Clipboard, 39  
clock frequency, 18  
clones, 10  
cold boot, 60  
communications  
program, 35  
complete system, 55  
Control panel, 50; 61;  
62  
controller card, 17  
copy, 39  
Corel Draw, 44; 56  
crash, 60; PC, 35

cursor, 38  
cut, 39  
database, 45  
data-bus. *see also* bus  
dBase, 45  
decimal system, 6  
delete, 38  
desktop, 33  
desktop cabinet, 13  
directories, 32  
directory, 34  
discount, 28; 57  
diskette, 14; 21; 32;  
HD, 15  
DOS, 10; 12; 24; 32; 49  
DOS Prompt, 25  
dot matrix printer, 57  
Drag & Drop, 37; 47  
drawing program, 44  
drive letter, 31  
driver, 30  
DTP, 40  
DVD, 15  
electronic valves, 6  
e-mail, 35; 52  
ENIAC, 7; 12  
Enter key, 25; 39  
Escape, 39  
Excel, 41; 57; 59  
executable file, 31  
exe-file. *see* start file  
Explorer, 38  
fax function, 35  
file: extension, 30;  
types, 30  
file manager, 32  
file name, 30; 31; 34;  
DOS rules, 35  
flight simulators, 48  
floppy disk, 14  
folder, 34  
folders, 32  
font, 40  
formula, 41  
freeware, 59  
gamepad, 47  
games, 48  
Gates, Bill, 13; 38  
graphic programs, 59  
graphic user interface,  
26  
hard disk, 19; 30; 32  
High Color, 62

Hyperlink. *also see* Link  
IBM, 7; 9; 12; 27; 47  
IBM PC, 9; 10; 12; 24  
IC, 8; 12  
ink-jet printer, 58  
Intel, 9  
Internet, 52; 59  
ISDN, 52; 56  
ISP, 52  
joystick, 47; 48  
keyboard, 14; 39  
laptop, 13  
laser printer, 58  
license, 59  
Link, 52  
Linux, 28  
long file name, 35  
mailbox, 52  
mainframe, 9  
mathematical functions,  
41  
menu bar, 36  
microphone, 14; 17; 46  
Microsoft, 10; 12; 13;  
33; 34  
Midi file, 30; 46  
Midi keyboard, 46; 55  
minitower, 13  
MMX, 18; 56  
modem, 52  
monitor, 14; screen  
diagonal, 14  
motherboard, 17; 21  
mouse, 8; 10; 14; 16  
mouse pad, 15  
MPEG-video, 51  
MS-DOS, 10; 24  
Multimedia, 11; 35; 50  
multitasking, 27  
music, 45  
**My computer**, 33; 37  
Netscape Navigator, 53  
network card, 17  
Norton Commander, 32  
notebook, 13; 16; 57  
Novell Netware, 29  
OEM, 59  
on-line services, 52  
Opera, 53  
operating system, 10;  
23; 29  
OS/2, 27; 29; 34  
PageMaker, 11; 40

Paint, 30; 35; 44  
Paintbrush, 35; 44  
painting program, 44  
paste, 39  
PCI bus, 22  
Pentium, 18; 49; 55  
Photoshop, 44; 56; 59  
pirate copies, 59  
pixel, 44  
Plug&Play, 35  
Postscript, 58  
power supply, 17  
printer, 14  
processor, 18  
program: installation, 31  
prompt. *see also* DOS Prompt  
Provider, 52  
Public Domain, 59  
RAM, 19; 24  
reboot: warm, 60  
Recycle bin, 33; 34  
refresh rate, 14  
repairing: PC, 61  
Reset button, 60  
resolution: printer, 58  
root directory, 32  
save, 20; 32; 37  
scan, 44  
scanner, 56  
select, 39  
sequencer, 46  
Shareware, 49; 51; 59; 60  
shut down, 60  
SimCity, 49  
software, 59  
sound, 50  
sound card, 13; 14; 15; 16; 45; 46; 49; 51  
Soundblaster, 47  
speakers, 14; 17; 47  
spreadsheet, 40  
spreadsheets, 59  
start diskette, 61  
start file, 31; 38  
StarWriter, 60  
status line, 36  
SuperVGA, 62  
Surfing the Internet, 53  
System 7, 29; 34  
system menu, 36  
**taskbar**, 33  
TCP/IP, 52  
terminal, 9  
TextMaker, 40  
toolbar, 36; 40  
tower, 13  
trackball, 16  
transistor, 7  
trash can, 11  
True Color, 62  
UNIVAC, 7; 12  
Unix, 28; 34  
upgrade: PC, 55  
upgrading: PC, 61  
used PC, 55  
valve, 9  
valves, 12  
VGA, 62  
video, 50; 51  
virus, 61  
VLB bus, 22  
waste-basket, 29  
Wave files, 30; 45  
wavetable, 46; 47  
web pages, 52  
window, 36  
Windows, 16; 26; 29; 33; 34; 35; 44; 51  
Windows 2000, 29  
Windows 95: shut down computer, 34; start menu, 36  
Windows NT, 29  
Word, 30; 38; 40; 57; 59  
word processing, 39; 56  
word processor, 38; 59  
Wordpad, 35; 38  
WordPerfect, 40  
WordPro, 40  
work position, 62  
Works, 57  
World Wide Web, 52  
Xerox, 8; 10; 12  
Z3, 6; 12  
Zuse, Konrad, 6; 12